

Panasonic®

Operating Instructions

LCD Video Monitor

Model No. **BT-3DL2550P**

Model No. **BT-3DL2550E**

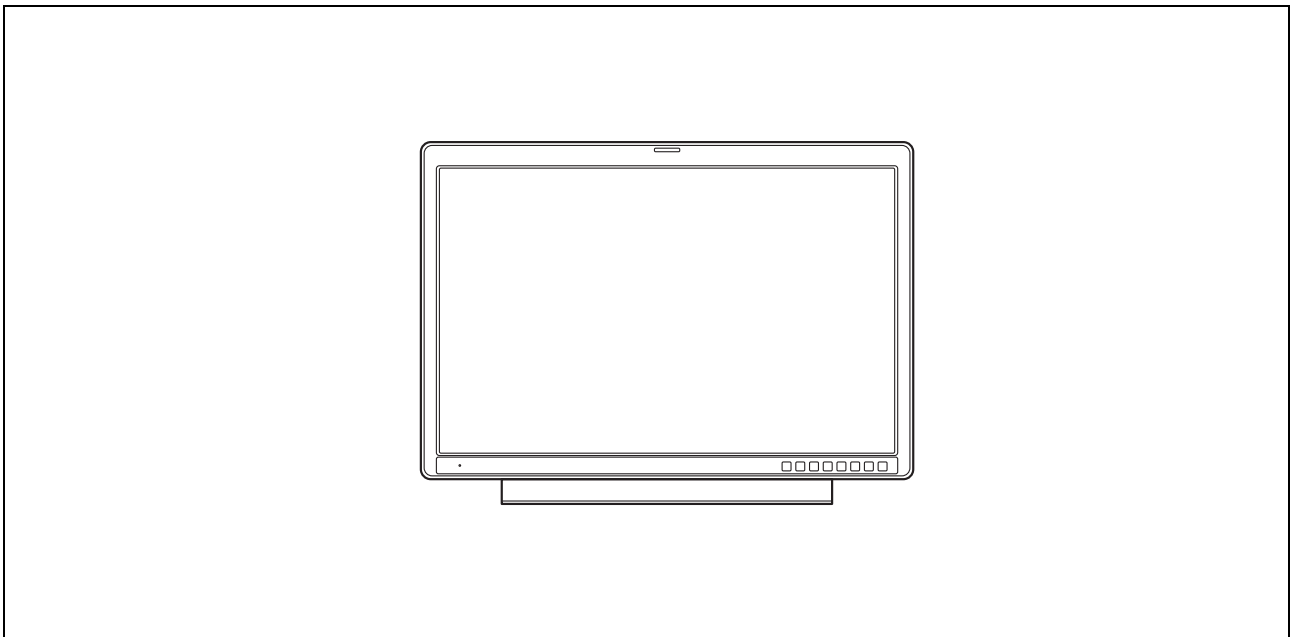

ESPAÑOL

Para la explicación en español, consulte el CD-ROM suministrado.

Before operating this product, please read the instructions carefully and save this manual for future use.

Read this first! (for BT-3DL2550P)



CAUTION: TO REDUCE THE RISK OF ELECTRIC SHOCK, DO NOT REMOVE COVER (OR BACK). NO USER-SERVICEABLE PARTS INSIDE. REFER SERVICING TO QUALIFIED SERVICE PERSONNEL.



The lightning flash with arrowhead symbol, within an equilateral triangle, is intended to alert the user to the presence of uninsulated "dangerous voltage" within the product's enclosure that may be of sufficient magnitude to constitute a risk of electric shock to persons.



The exclamation point within an equilateral triangle is intended to alert the user to the presence of important operating and maintenance (servicing) instructions in the literature accompanying the appliance.

WARNING:

- To reduce the risk of fire or electric shock, do not expose this equipment to rain or moisture.
- To reduce the risk of fire or electric shock, keep this equipment away from all liquids. Use and store only in locations which are not exposed to the risk of dripping or splashing liquids, and do not place any liquid containers on top of the equipment.

WARNING:

This apparatus must be grounded.

To ensure safe operation the three-pin plug must be inserted only into a standard three-pin power point which is effectively earthed through the normal household wiring. Extension cords used with the equipment must be three-core and be correctly wired to provide connection to earth. Wrongly wired extension cords are a major cause of fatalities. The fact that the equipment operates satisfactorily does not imply that the power point is earthed and that the installation is completely safe. For your safety, if in any doubt about the effective earthing of the power point, consult a qualified electrician.

WARNING:

Always keep accessories (power cable hook, screw) out of the reach of babies and small children.

WARNING:

Installation should only be performed by qualified installation personnel. Improper installation may result in the entire apparatus falling down and causing injury.

CAUTION:

The mains plug of the power supply cord shall remain readily operable. The AC receptacle (mains socket outlet) shall be installed near the equipment and shall be easily accessible. To completely disconnect this equipment from the AC mains, disconnect the mains plug from the AC receptacle.

CAUTION:

In order to maintain adequate ventilation, do not install or place this unit in a bookcase, built-in cabinet or any other confined space. To prevent risk of electric shock or fire hazard due to overheating, ensure that curtains and any other materials do not obstruct the ventilation.

CAUTION:

To reduce the risk of fire or electric shock and annoying interference, use the recommended accessories only.

CAUTION:

This apparatus can be operated at a voltage in the range of 100 - 240 V AC. Voltages other than 120 V are not intended for U.S.A. and Canada.

CAUTION:

Operation at a voltage other than 120 V AC may require the use of a different AC plug. Please contact either a local or foreign Panasonic authorized service center for assistance in selecting an alternate AC plug.

CAUTION:

Excessive sound pressure from earphones and headphones can cause hearing loss.

CAUTION:

This Monitor is for use only with Panasonic Wall Mount Adaptor, BT-WMA26G. Use with other Wall Mount is capable of resulting in instability causing possible injury.

CAUTION:

Check the installation at least once a year. An improper installation could cause the monitor to fall off resulting in personal injury.

CAUTION:

Remove the wall mount adaptor when not used. Otherwise people moving in the vicinity of the monitor could get caught on the bracket and be injured.

 indicates safety information.

AC Adapter

The rating plate is on the underside of the AC Adapter.

Notice (U.S.A. only):

This product has a fluorescent lamp that contains mercury. Disposal may be regulated in your community due to environmental considerations. For disposal or recycling information, please contact your local authorities, or the Electronic Industries Alliance: <http://www.eiae.org>.

Read this first! (for BT-3DL2550P) (continued)

FCC NOTICE (USA)

Declaration of Conformity

Model Number: BT-3DL2550P
Trade Name: Panasonic
Responsible Party: Panasonic Corporation of North America
One Panasonic Way, Secaucus, NJ07094
Support contact: 1-800-524-1448

This device complies with Part 15 of the FCC Rules.

Operation is subject to the following two conditions:

(1) This device may not cause harmful interference, and (2) this device must accept any interference received, including interference that may cause undesired operation.

To assure continued compliance, follow the attached installation instructions and do not make any unauthorized modifications.

Note:

This equipment has been tested and found to comply with the limits for a class B digital device, pursuant to Part 15 of the FCC Rules. These limits are designed to provide reasonable protection against harmful interference in a residential installation. This equipment generates, uses, and can radiate radio frequency energy, and if not installed and used in accordance with the instructions, may cause harmful interference to radio communications. However, there is no guarantee that interference will not occur in a particular installation. If this equipment does cause harmful interference to radio or television reception, which can be determined by turning the equipment off and on, the user is encouraged to try to correct the interference by one of the following measures:

- Reorient or relocate the receiving antenna.
- Increase the separation between the equipment and receiver.
- Connect the equipment into an outlet on a circuit different from that to which the receiver is connected.
- Consult the dealer or an experienced radio/TV technician for help.

The user may find the booklet "Something About Interference" available from FCC local regional offices helpful.

Warning:

To assure continued FCC emission limit compliance, follow the attached installation instructions and the user must use only shielded interface cables when connecting to host computer or peripheral devices. If DVI-D port is to be used it must be connected to PC by compatible interface cable with two ferrite cores. Also, any unauthorized changes or modifications to this equipment could void the user's authority to operate this device.

IMPORTANT SAFETY INSTRUCTIONS

- 1) Read these instructions.
- 2) Keep these instructions.
- 3) Heed all warnings.
- 4) Follow all instructions.
- 5) Do not use this apparatus near water.
- 6) Clean only with dry cloth.
- 7) Do not block any ventilation openings. Install in accordance with the manufacturer's instructions.
- 8) Do not install near any heat sources such as radiators, heat registers, stoves, or other apparatus (including amplifiers) that produce heat.
- 9) Do not defeat the safety purpose of the polarized or grounding-type plug. A polarized plug has two blades with one wider than the other. A grounding-type plug has two blades and a third grounding prong. The wide blade or the third prong are provided for your safety. If the provided plug does not fit into your outlet, consult an electrician for replacement of the obsolete outlet.
- 10) Protect the power cord from being walked on or pinched particularly at plugs, convenience receptacles, and the point where they exit from the apparatus.
- 11) Only use attachments/accessories specified by the manufacturer.
- 12) Use only with the cart, stand, tripod, bracket, or table specified by the manufacturer, or sold with the apparatus. When a cart is used, use caution when moving the cart/apparatus combination to avoid injury from tip-over.
- 13) Unplug this apparatus during lightning storms or when unused for long periods of time.
- 14) Refer all servicing to qualified service personnel. Servicing is required when the apparatus has been damaged in any way, such as power-supply cord or plug is damaged, liquid has been spilled or objects have fallen into the apparatus, the apparatus has been exposed to rain or moisture, does not operate normally, or has been dropped.



S3125A

Read this first! (for BT-3DL2550E)

WARNING:

This apparatus must be earthed. To ensure safe operation the three-pin plug must be inserted only into a standard three-pin power point which is effectively earthed through the normal house-hold wiring. Extension cords used with the equipment must be three-core and be correctly wired to provide connection to earth. Wrongly wired extension cords are a major cause of fatalities. The fact that the equipment operates satisfactorily does not imply that the power point is earthed and that the installation is completely safe. For your safety, if in any doubt about the effective earthing of the power point, consult a qualified electrician.

WARNING:

- To reduce the risk of fire or electric shock, do not expose this equipment to rain or moisture.
- To reduce the risk of fire or electric shock, keep this equipment away from all liquids. Use and store only in locations which are not exposed to the risk of dripping or splashing liquids, and do not place any liquid containers on top of the equipment.

WARNING:

Always keep accessories (AC mains lead hook, screw) out of the reach of babies and small children.

WARNING:

Installation should only be performed by qualified installation personnel. Improper installation may result in the entire apparatus falling down and causing injury.

CAUTION:

Do not remove panel covers by unscrewing them. To reduce the risk of electric shock, do not remove the covers. No user serviceable parts inside. Refer servicing to qualified service personnel.

CAUTION:

The mains plug of the power supply cord shall remain readily operable. The AC receptacle (mains socket outlet) shall be installed near the equipment and shall be easily accessible. To completely disconnect this equipment from the AC mains, disconnect the mains plug from the AC receptacle.

CAUTION:

To reduce the risk of fire or electric shock and annoying interference, use the recommended accessories only.

CAUTION:

In order to maintain adequate ventilation, do not install or place this unit in a bookcase, built-in cabinet or any other confined space. To prevent risk of electric shock or fire hazard due to overheating, ensure that curtains and any other materials do not obstruct the ventilation.

CAUTION:

Excessive sound pressure from earphones and headphones can cause hearing loss.

CAUTION:

This Monitor is for use only with Panasonic Wall Mount Adaptor, BT-WMA26G. Use with other Wall Mount is capable of resulting in instability causing possible injury.

CAUTION:

Check the installation at least once a year. An improper installation could cause the monitor to fall off resulting in personal injury.

CAUTION:

Remove the wall mount adaptor when not used. Otherwise people moving in the vicinity of the monitor could get caught on the bracket and be injured.

 indicates safety information.

AC Adapter

The rating plate is on the underside of the AC Adapter.

Operating precaution

Operation near any appliance which generates strong magnetic fields may give rise to noise in the video and audio signals. If this should be the case, deal with the situation by, for instance, moving the source of the magnetic fields away from the unit before operation.

EEE Yönetmeliğine Uygundur.
EEE Complies with Directive of Turkey.

Caution for AC Mains Lead

FOR YOUR SAFETY PLEASE READ THE FOLLOWING TEXT CAREFULLY.

This product is equipped with 2 types of AC mains cable, Type C and Type BF.

Appropriate mains cable must be used in each local area, since the other type of mains cable is not suitable.

TYPE C

For continental Europe, Russia, etc.
Not to be used in the U.K.

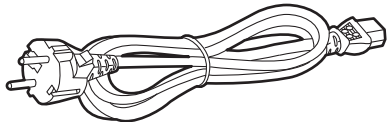

TYPE BF

For U.K., etc.

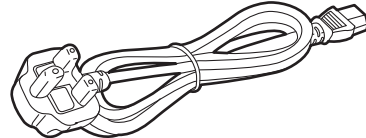



TYPE BF

This appliance is supplied with a moulded three pin mains plug for your safety and convenience.

A 13 amp fuse is fitted in this plug.

Should the fuse need to be replaced please ensure that the replacement fuse has a rating of 13 amps.

For U.K. only

The replacement fuse must be approved by ASTA or BSI to BS1362. Check for the ASTA mark  or the BSI mark  on the body of the fuse.

If the plug contains a removable fuse cover you must ensure that it is refitted when the fuse is replaced.

If you lose the fuse cover the plug must not be used until a replacement cover is obtained.

A replacement fuse cover can be purchased from your local Panasonic Dealer.

How to replace the fuse

1. Open the fuse compartment with a screwdriver.

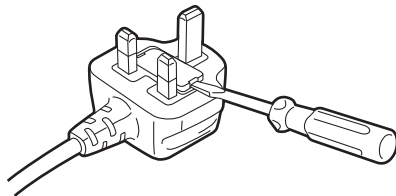

2. Replace the fuse.

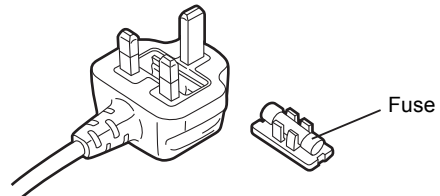

 indicates safety information.

EMC NOTICE FOR THE PURCHASER/USER OF THE APPARATUS

1. Applicable standards and operating environment (BT-3DL2550E)

The apparatus is compliant with:

- standards EN55103-1 and EN55103-2 1996.11, and
- electromagnetic environments E1, E2, E3 and E4

2. Pre-requisite conditions to achieving compliance with the above standards

<1> Peripheral equipment to be connected to the apparatus and special connecting cables

- The purchaser/user is urged to use only equipment which has been recommended by us as peripheral equipment to be connected to the apparatus.
- The purchaser/user is urged to use only the connecting cables described below.

<2> For the connecting cables, use shielded cables which suit the intended purpose of the apparatus.

- Video signal connecting cables
Use double shielded coaxial cables, which are designed for 75-ohm type high-frequency applications, for SDI (Serial Digital Interface).
Coaxial cables, which are designed for 75-ohm type high-frequency applications, are recommended for analog video signals.
- Audio signal connecting cables
If your apparatus supports AES/EBU serial digital audio signals, use cables designed for AES/EBU. Use shielded cables, which provide quality performance for high-frequency transmission applications, for analog audio signals.
- Other connecting cables (IEEE1394, USB)
Use shielded cables, which provide quality performance for high-frequency applications, as connecting cables.
- When connecting to the DVI signal terminal, use a cable with a ferrite core.
- If your apparatus is supplied with ferrite core(s), they must be attached on cable(s) following instructions in this manual.
- Use a sealed type cable (D-SUB 9 pin) for connecting to the GPI terminal.

3. Performance level

The performance level of the apparatus is equivalent to or better than the performance level required by these standards.

However, the apparatus may be adversely affected by interference if it is being used in an EMC environment, such as an area where strong electromagnetic fields are generated (by the presence of signal transmission towers, cellular phones, etc.). In order to minimize the adverse effects of the interference on the apparatus in cases like this, it is recommended that the following steps be taken with the apparatus being affected and with its operating environment:

1. Place the apparatus at a distance from the source of the interference.
2. Change the direction of the apparatus.
3. Change the connection method used for the apparatus.
4. Connect the apparatus to another power outlet where the power is not shared by any other appliances.

Pursuant to at the directive 2004/108/EC, article 9(2)
Panasonic Testing Centre
Panasonic Service Europe, a division of Panasonic Marketing Europe GmbH
Winsbergring 15, 22525 Hamburg, F.R. Germany

Cautions

About 3D Polarized Eyewear

- Do not drop, exert pressure on, or step on the 3D Polarized Eyewear.
- Be careful not to trap a finger in the hinge section of the 3D Polarized Eyewear.
- Always store the 3D Polarized Eyewear in the case provided when not in use.
- Be careful of the tips of the frame when putting on the 3D Polarized Eyewear.

Viewing 3D Content

- Use this monitor at the recommended viewing distance.
(Recommended viewing distance: 80cm approx.)
- Aim to take breaks of between 30 - 60 minutes as appropriate when viewing 3D content.
- As a guideline, do not allow children younger than 5 - 6 years old to view 3D content.
- Stop using the 3D Polarized Eyewear immediately if you feel tired, discomfort, or any other uncomfortable sensation.
- Be aware of objects and people in your surroundings when viewing 3D content.
- The 3D Polarized Eyewear must only be worn when viewing 3D content.
- Do not tilt your head and/or the 3D Polarized Eyewear while viewing 3D image.
- Keep your eyes and the 3D Polarized Eyewear is on a horizontal level to the television.
- If you suffer from any eyesight problems (short/far-sighted, astigmatism, eyesight differences in left and right), please ensure to correct your vision before using the 3D Polarized Eyewear.
- Stop using the 3D Polarized Eyewear if you can clearly see double images when viewing 3D content.
- Do not use the 3D Polarized Eyewear if you have a history of over-sensitivity to light, heart problems, or have any other existing medical conditions.

3D Polarized Eyewear Use

- Stop using the 3D Polarized Eyewear immediately if you feel tired, discomfort, or any other uncomfortable sensation.
- Remove the 3D Eyewear before moving around to avoid falling or accidental injury.
- Use the 3D Polarized Eyewear only for the intended purpose and nothing else.
- Stop using the 3D Polarized Eyewear immediately if a malfunction or fault occurs.
- Do not use if the 3D Polarized Eyewear is physically damaged.
- Immediately discontinue use of 3D Polarized Eyewear if they are damaged or faulty.
- In rare cases, the materials used in the 3D Polarized Eyewear may cause an allergic reaction.
- Stop using the 3D Eyewear immediately if you experience any redness, pain, or skin irritation around the nose or temples.
- Do not use the 3D Polarized Eyewear if you have a history of over-sensitivity to light, heart problems, or have any other existing medical conditions.

Transportation precautions

Do not try to lift the monitor by grabbing the panel.

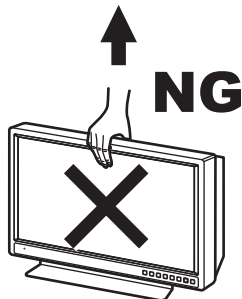

Do not place the monitor face down during transportation to prevent damaging it. Keep it upright.



Do not expose the LCD panel to strong pressure or pressure from pointed objects. Take care especially during transportation.

Exposing the LCD panel to strong pressure may result in blurring or other damage.

Precautions for Use

- The LCD screen is manufactured to precise specifications. Although over 99.99% of the pixels function normally, 0.01% of the pixels are either missing or constantly lit (red, blue or green). This is normal and not a cause for concern.
- The liquid crystal protection panel is a specially manufactured component. Wiping it with a hard cloth, or rubbing it vigorously will scratch the surface.
- If a still image is displayed for an extended period of time, it may generate a temporary afterimage (phosphor burn-in). (However, such images can be removed by displaying normal video for a while.)
- The response speed and brightness of liquid crystal vary with ambient temperatures.
- Let authorized service person handle installation.
Be sure to consult with the service person about the installation. Make sure that the wall is strong enough to endure the weight of this unit including the mount fittings. If not strong enough, it may fall off resulting in injury.
- Do not install the unit in a place exposed to direct sunlight, as it may damage the cabinet and the LCD screen.
- Do not install the unit in locations where enough space cannot be provided around it as heat may build up inside preventing normal operation. Be sure to provide enough space around the unit.
- Exposing the LCD screen to intense light sources will impair its characteristics and lower image quality.
- In an environment exposed to drastic temperature fluctuations, condensation may build up on and inside the LCD screen. This may lower the quality of the screen and may damage it.
- Some video images may appear blurred on the screen.
- Leaving the unit in a location exposed to high temperature and humidity for an extended period of time may damage the LCD screen and cause blurring.

Contents

Read this first!	2	MARKER	25
Cautions	7	Marker types	27
Transportation precautions	7	VIDEO CONFIG	29
Precautions for Use	8	SYSTEM CONFIG	32
Standard accessories	8	FUNCTION	35
Optional units	8	GPI	39
Outline	9	INPUT SELECT	40
Dimensions	11	AUDIO	42
Controls and Their Functions	12	DISPLAY SETUP	43
Video monitor unit	12	CONTROL	48
Front panel controls	13	HOURMETER	48
Rear panel terminals	14	REMOTE Specifications	53
AC Adapter	15	Maintenance inspections	57
Power Supply	16	Care and cleaning of the monitor	58
How to Use the On Screen Menu	17	Care and storage of 3D Polarized Eyewear	58
User Data	22	Error Display	58
Main Menu	23	Before calling for support	58
Menu configuration	23	Specifications	59
3D	24		

Standard accessories

<For BT-3DL2550P>

- Power cable × 1
- Power cable hook × 1
- Screw × 1 (for securing power cable)
- AC Adaptor × 1 (VEK0N61)
- DC cable × 1
- CD-ROM × 1
- 3D Polarized Eyewear (BT-PGL10G) × 2

<For BT-3DL2550E>

- AC mains lead × 2
- AC mains lead hook × 1
- Screw × 1 (for securing AC mains lead)
- AC Adaptor × 1 (VEK0N62)
- DC cable × 1
- CD-ROM × 1
- 3D Polarized Eyewear (BT-PGL10G) × 2

Optional units

- Wall Mount Adaptor** BT-WMA26G (Leave installation of the wall mount adaptor to authorized personnel.)
- 3D Polarized Eyewear** BT-PGL10G (same as those included with unit)

Outline

The BT-3DL2550P/E LCD monitor is a 64.8 cm (25.5 inch) full HD LCD display panel designed especially for broadcasting service and business use.

■ Compact 25.5 type full HD monitor

- The monitor is equipped with a high-resolution (1920 x 1200) IPS LCD panel.
- Efforts to develop a small footprint have resulted in a surprisingly compact design for a monitor with a screen size of 64.8 cm (25.5 inches).

■ Wide color gamut panel and 10-bit 3D LUT for faithful color reproduction

- The wide color gamut panel increases the origin coordinate accuracy of broadcast standard RGB and 3D LUT improves color reproduction. It is also compatible with the wide color gamut modes for the Adobe RGB and D-Cinema (D-Cinema min. Color Gamut) standards.

■ A new image processing engine for improved video quality

- 10-bit image processing accurately and smoothly reproduces color from low to high brightness levels.
- Built-in I/P converter circuit with a delay of less than 1 field minimizes the delay between input signal to picture display.
- Diagonal line compensation processing circuit reduces vertical image degradation and jagged noise in the diagonal direction.
- High-speed motion response results in crisp image reproduction without blurring.
- The gamma correction of each monitor is set individually prior to shipment.

■ Multi-format image compatibility

- This monitor is equipped with SDI (HD/SD compatible), VIDEO, YP_BPR/RGB, DVI-D (HDCP compatible) input jacks.
- It supports both NTSC and PAL TV broadcast systems.

■ 3D display function

Along with a standard 2D display function, this monitor is equipped with a function that displays a left-eye and right-eye image on each line, creating a 3D (stereoscopic) image when viewed through the 3D Polarized Eyewear provided.

Due to the characteristics of the Xpol[®] polarizing filter, 3D images should be viewed from a position directly in front of the LCD screen.

The supplied 3D Polarized Eyewear can be worn over regular prescription glasses.

- Compatible with various input types

SIMULTANEOUS (SIMUL)

The monitor converts left-eye and right-eye video input from the SDI1 and SDI2 terminals into a 3D image.

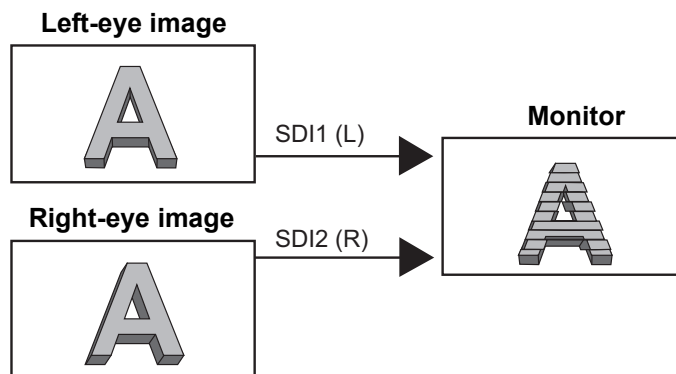

LINE BY LINE

Left-eye and right-eye video is combined into a single image using an external device and the image is input from SDI1, SDI2, or DVI-D and displayed as a 3D image by the monitor.

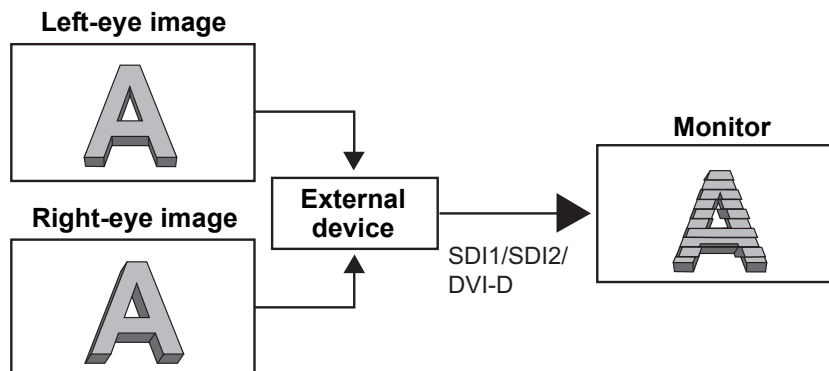

Outline (continued)

SIDE BY SIDE

A signal split into video for left-eye and right-eye and arranged side by side is input from either SDI1 or SDI2 and converted into a 3D image and displayed by the monitor.

Input through DVI-D is also supported.

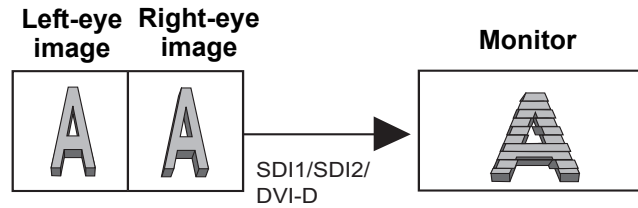

- 3D display adjustment function
This function can horizontally invert the right-eye image and shift its position horizontally.
- Support for various display formats
Multiple formats to check the difference between left-eye and right-eye images are also provided.

OVERLAY

Video for the left-eye and right-eye is overlaid on a single screen and displayed on the monitor.

SDI1 (L)/SDI2 (R)

When SDI1 is selected video input from SDI1 (L) is displayed on a single screen, and when SDI2 is selected video input from SDI2 (R) is displayed on a single screen.

COMPARISON

Video for the left-eye and right-eye is displayed separately side by side.

■ A host of functions

- Split-screen function **2D ONLY**
You can display two selected inputs in two windows and set a separate color space and gamma value for image comparison.
- Time code display
During HD SDI input, you can select to display VITC, LTC or UB time code. When in 3D mode, the time code from the SDI1 terminal input signal is displayed.
- Closed caption **2D ONLY**
During VIDEO (NTSC) input, this feature displays the closed caption information embedded in the video signal. (EIA-608 compliant)
- Cross hatch overlay function
Displays markers at regular vertical and horizontal intervals to facilitate composition.

■ Calibration function

The monitor can easily be calibrated using a luminance meter.

■ REMOTE control

Depending on the intended use of the monitor, you can select between parallel remote control (GPI) and serial remote control (RS-232C).

In these operating instructions, points that apply only when displaying 3D images are marked **3D ONLY**, and points that apply only when displaying 2D images are marked **2D ONLY**.

- Xpol® is a registered trademark of Arisawa Mfg. Co., Ltd.
- Adobe is the registered trademark or trademark of Adobe System Incorporated in the United States and other countries.
- Other company names and product names are the trademarks or registered trademarks of their respective owners.

Dimensions

Video monitor unit

Unit: mm (inches)

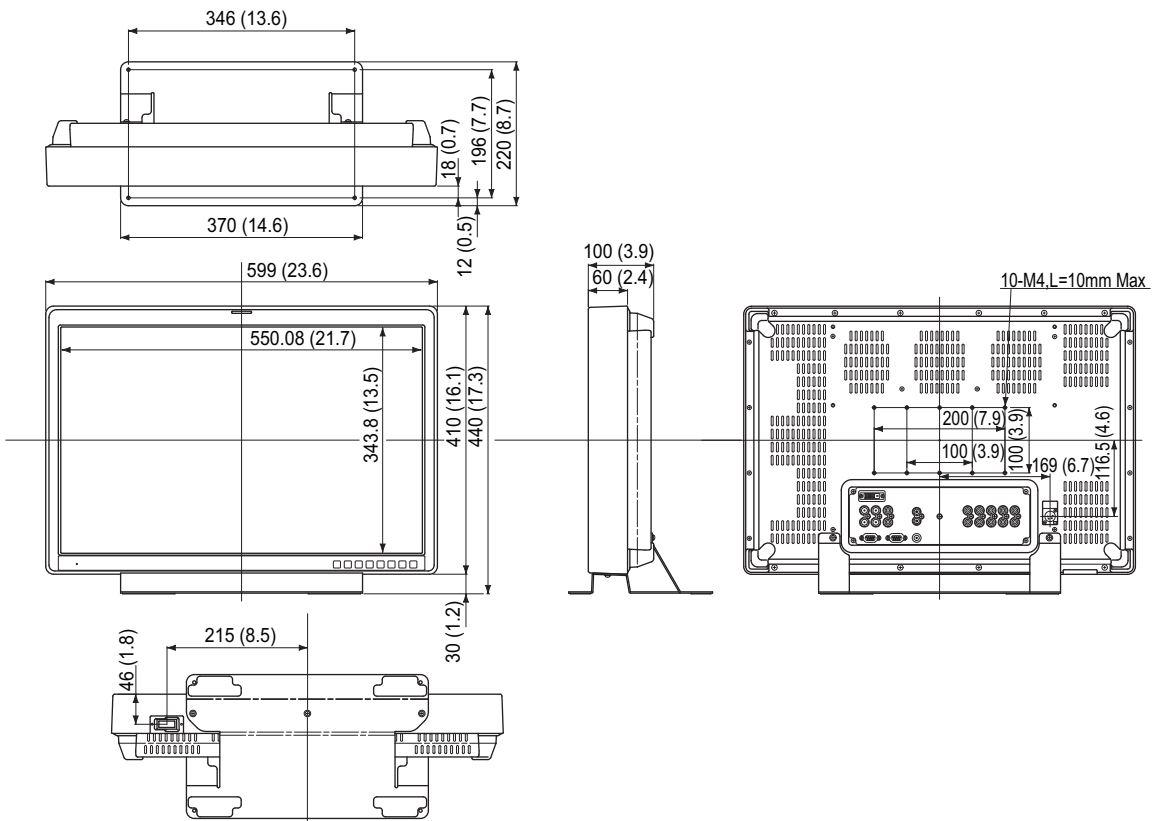

- When installing the monitor in one place permanently, we recommend that you fix the monitor in place using the screw holes in the lower part of the stand.

AC Adaptor

Unit: mm (inches)

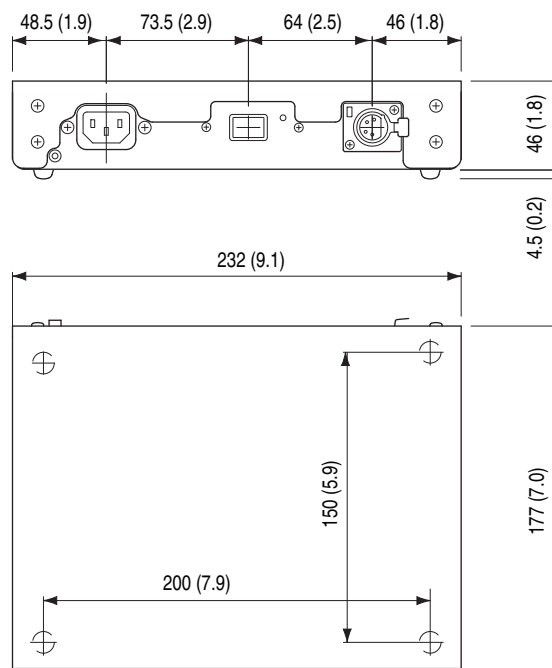

- The rating plate is on the underside of the AC Adaptor.

Controls and Their Functions

Video monitor unit

Front view

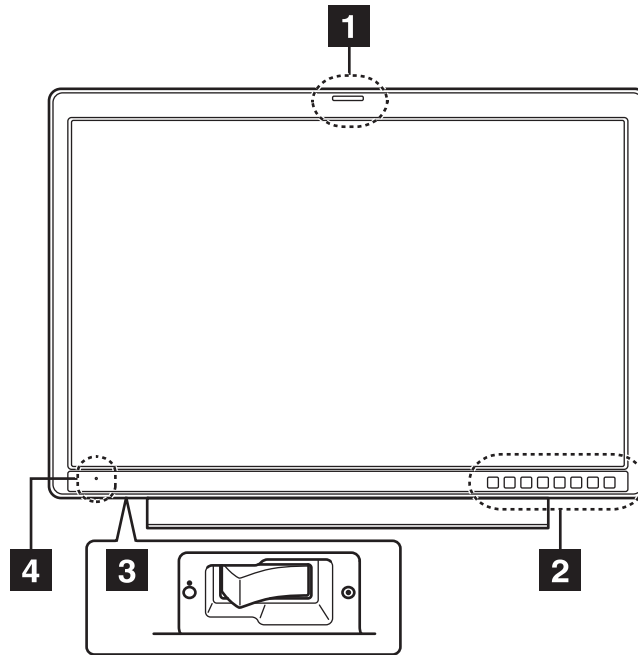

Rear view

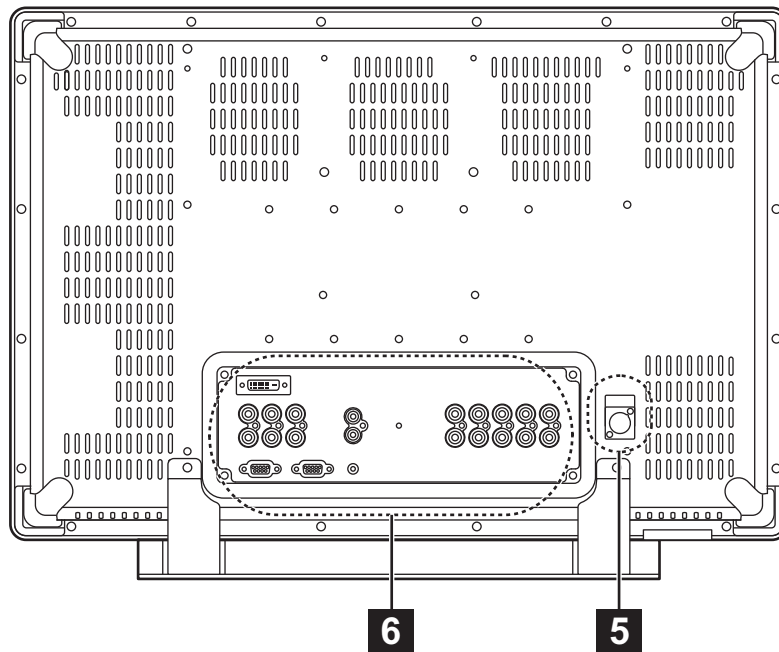

- 1 Tally lamp** (→page 39, 53)
The color of the tally lamp indicates monitor status. Red tally or green tally displayed according to GPI input.
- 2 Front panel controls** (→page 13)
- 3 POWER switch** (●/○)
The POWER switch is located at the bottom of the front panel.
This switch turns the power On and Off. Set the switch to ● to turn it on.
- 4 Power LED**
When the power is turned on, the LED lights green.
- 5 DC IN**
Connect the supplied DC cable of the supplied AC adapter to this terminal.
- 6 Rear panel terminals** (→page 14)

Controls and Their Functions (continued)

Front panel controls

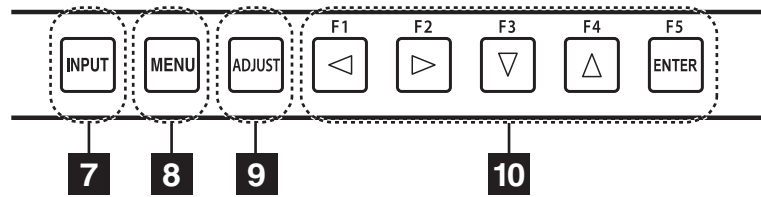

7 INPUT button (INPUT)

Selects the signal input line.

Each press of the button changes the lines in the following order: VIDEO → SDI1 → SDI2 → YP_BP_R/RGB → DVI-D.

VIDEO : VIDEO input (analog composite signal)

SDI1 : Serial digital interface input (HD/SD compatible)

SDI2 : Serial digital interface input (HD/SD compatible)

YP_BP_R/RGB : Analog component input (YP_BP_R) or RGB input also compatible with RGB input from a PC.

DVI-D : DVI-D input (HDCP compatible)

• When the power is turned on, the input line used when the power was last turned off is selected.

The INPUT menu can be set to skip input lines that are not used.

• VIDEO and YP_BP_R/RGB cannot be selected while in 3D mode.

8 MENU button (MENU)

Press to open a menu, exit a menu or return to a previous menu.

9 ADJUST button (ADJUST)

Press to display the picture/volume adjusting menu (PHASE, CHROMA, BRIGHT, B.LIGHT [BACKLIGHT] or CONT. [CONTRAST], VOLUME).

10 Cursor, ENTER, FUNCTION buttons (◀, ▶, ▼, ▲, ENTER)

◀/FUNCTION1 : Moves the cursor to the left. Use to select the picture/volume adjusting menu or to confirm a menu item assigned to the FUNCTION1.

▶/FUNCTION2 : Moves the cursor to the right. Use to select the picture/volume adjusting menu or to confirm a menu item assigned to the FUNCTION2.

▼/FUNCTION3 : Moves the cursor downwards. Use to select the picture/volume adjusting menu or to confirm a menu item assigned to the FUNCTION3.

▲/FUNCTION4 : Moves the cursor upwards. Use to select the picture/volume adjusting menu or to confirm a menu item assigned to the FUNCTION4.

ENTER/FUNCTION5 : Confirms a menu selection and opens a submenu. It also confirms a menu item assigned to the FUNCTION5.

• When the control lock is on, the key mark appears and FUNCTION does not operate.

The buttons are made of plastic film. Do not use pointed objects such as fingernails, pens or screwdrivers to press the buttons as the resulting damage or deformation could prevent proper contact.

Controls and Their Functions (continued)

Rear panel terminals

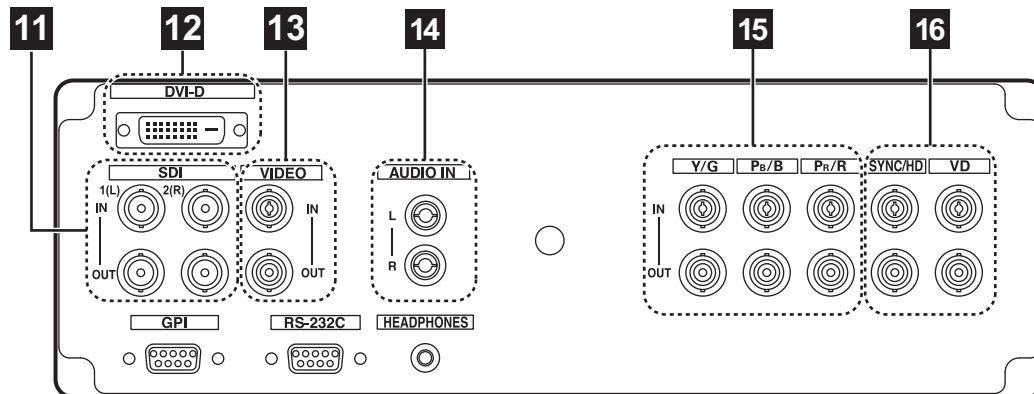

11 SDI terminal (BNC) *1*2

IN1 : This is the SDI input terminal (compatible with HD/SD automatic switching).

- In 3D mode with simultaneous double input (SIMUL), this is the L input terminal.

IN2 : This is the SDI input terminal (compatible with HD/SD automatic switching).

- In 3D mode with simultaneous double input (SIMUL), this is the R input terminal.

OUT1 : SDI output terminal (active through output)

- Output (active through) is available when the “SDI1” and “SDI2” options in the “INPUT SELECT” menu are set to “ON”, and “SDI1” or “SDI2” is selected via the INPUT button.

OUT2 : SDI output terminal (active through output)

- Output (active through) is available when the “SDI1” and “SDI2” options in the “INPUT SELECT” menu are set to “ON”, and “SDI1” or “SDI2” is selected via the INPUT button.

12 DVI-D terminal (DVI-D) *3

An HDCP compliant DVI-D signal input terminal.

13 VIDEO terminal (BNC) *4

IN : This is the VIDEO signal (analog composite signal) input terminal.

OUT : This is the input signal through-out terminal.

14 AUDIO IN terminal (pin jack)

This is the common audio input terminal for all video input terminals.

- Audio from SDI input is selected automatically when the “SDI1” and “SDI2” options in the “INPUT SELECT” menu are set to “ON”, and the “INPUT SELECT” option of the “AUDIO” menu is set to “AUTO”.

15 Y/G, P_B/B, P_R/R terminal (BNC) *4*5

IN : This is the YP_BP_R/RGB signal input terminal.

OUT : This is the input signal through-out terminal.

16 SYNC/HD, VD terminal (BNC) *6

IN : This is the input terminal for external synchronizing SYNC/HD, VD signals.

OUT : This is the input signal through-out terminal.

- When using RGB signals from a PC, connect the horizontal synchronizing signal to the SYNC/HD terminal, and the vertical synchronizing signal to the VD terminal.

*1 Use double-sealed type cables for connecting to SDI input/output terminals.

*2 When inputting 3D image signals, ensure that left and right signals are input into the correct terminal.

*3 Use a DVI cable with a ferrite core.

*4 Unless a cable is connected to the OUT terminal, the IN terminal is automatically terminated at 75 Ω.

Since a connection to the OUT terminal releases the 75 Ω termination of the unit, the level of the VIDEO signal input to the unit may become too large depending on the connected device.

*5 When a device is connected to the OUT terminal, 1080p and PC input and other broadband signals may distort character outlines and other details.

*6 Unless a cable is connected to the OUT terminal, the IN terminal is automatically terminated at 1 kΩ. Making a connection to the OUT terminal will automatically release the 1 kΩ termination.

Controls and Their Functions (continued)

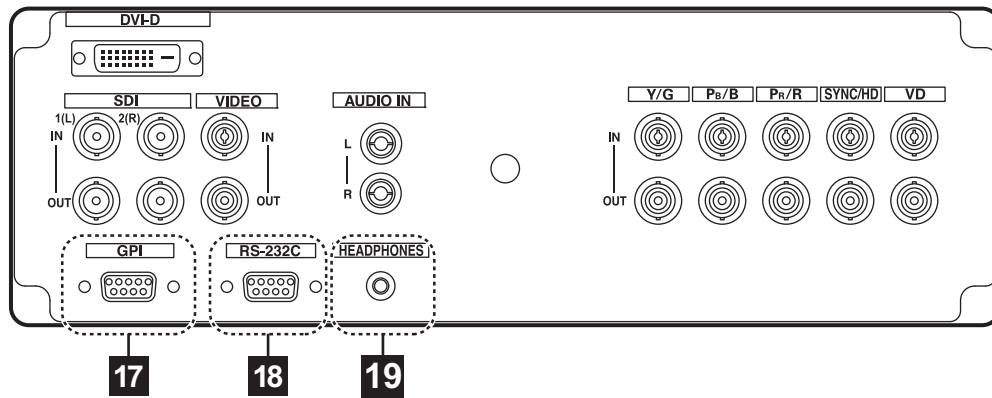

17 GPI input terminal (D-SUB 9-pin) *1

External control is possible by using a GPI signal.

18 RS-232C terminal (D-SUB 9-pin)

External control is possible by using an RS-232C signal.

19 HEADPHONES output connector (stereo mini-jack M3)

Connect a pair of headphones to monitor the sound.

- The sound volume and sound quality will depend on the headphones.

*1 Use a sealed type cable (D-SUB 9 pin) for connecting to the GPI terminal.

AC Adapter

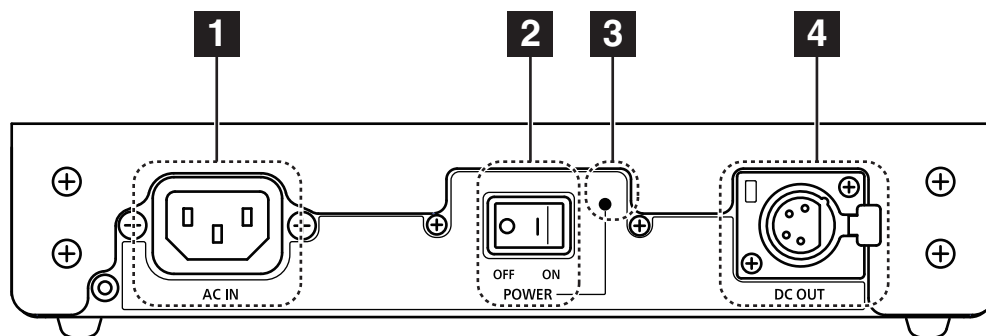

1 AC IN (AC inlet)

This is the AC input terminal.

2 POWER switch (ON : |, OFF : ○)

This switch turns the AC adapter on and off.

3 POWER lamp

This lamp lights green when the POWER switch is set to on.

4 DC OUT

This is the DC output terminal.

This terminal enables connection of a DC cable.

Power Supply

Connecting the power cable

1. Connect the power cable to the AC inlet of the AC adapter.

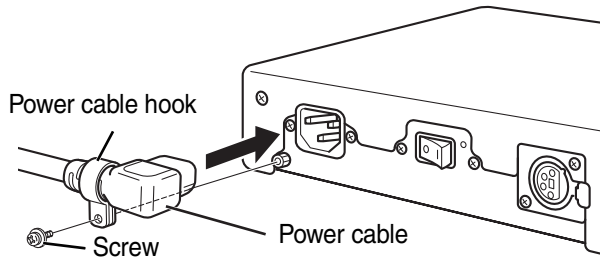

Use the supplied screw (for securing power cable) and the power cable hook to secure the power cable to the AC adapter.

2. Slide the supplied DC cable into the DC OUT terminal on the AC adapter until it is locked in place.

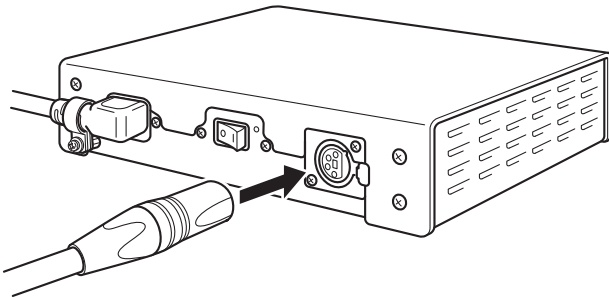

3. Slide the DC cable into the DC IN terminal on the unit until it locks in place.

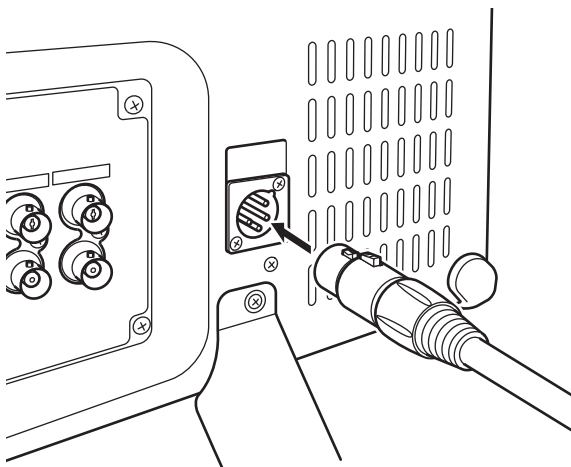

4. Connect the power cable to an AC outlet.

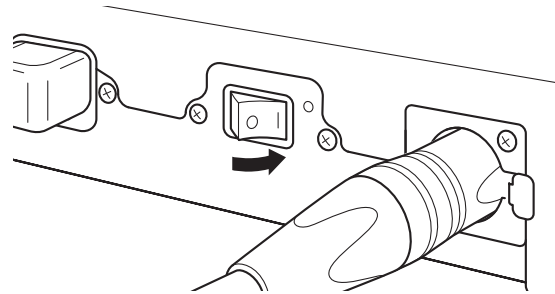

5. Turn on the POWER switch. The POWER LED lights green.

Be sure to use the supplied AC adapter.

Do not use the supplied AC adapter for powering other devices.

The AC adapter generates heat during use, which is normal and not a cause for concern.

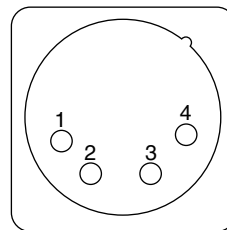

DC IN terminal

Pin number	Signal
1	GND
2	+5 V
3	+24 V
4	+24 V

How to Use the On Screen Menu

The screen displays eight types of information: input signal status, picture/volume adjusting menu status, sharpness display, FUNCTION display, audio level meter display, menu display, TIME CODE display and CLOSED CAPTION display.

Input signal status

2D mode

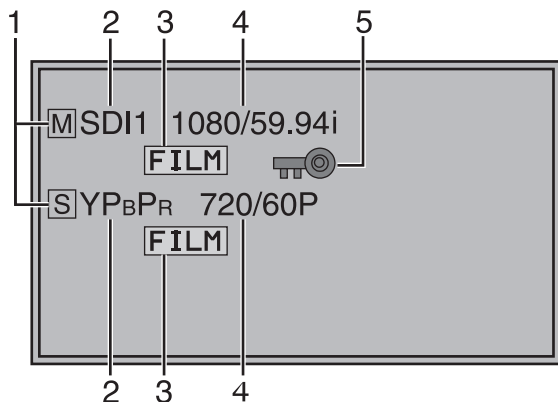

1. Main window **M**, sub-window **S** indication

- Indicates whether the main window or sub-window is displayed.
- In split screen display, the screen synchronized to the reference sync changes with the input signal format and "TWO WINDOW SIZE" settings (→ page 47). The screen synchronized to the reference sync is displayed in white and the screen that is not synchronized is displayed in yellow.

2. The selected input line (→ page 13, **7**)

- VIDEO, SDI1, SDI2, YP_BP_R/RGB-VIDEO/RGB-COMP. DVI-VIDEO/DVI-COMP.
- Use "STATUS DISPLAY" in the "SYSTEM CONFIG" menu to set the display status (→ page 32).

3. Various indications (FILM mode)

- This indicates that "GAMMA SELECT" is set to "FILM" in the "VIDEO CONFIG" menu.

4. Signal format

- Use "STATUS DISPLAY" in the "SYSTEM CONFIG" menu to set the display status (→ page 32).
- "UNSUPPORT SIGNAL" appears if an unsupported signal is input. It may also indicate that the format selected in the "INPUT SELECT" menu does not match the input signal.
- "NO SIGNAL" appears if no signal is input.

Note:

"UNSUPPORT SIGNAL" and "NO SIGNAL" may not be properly displayed.

5. Various indications (Lock status)

- This indicates that "CONTROL" is set to "REMOTE" in the "CONTROL" menu.

3D mode

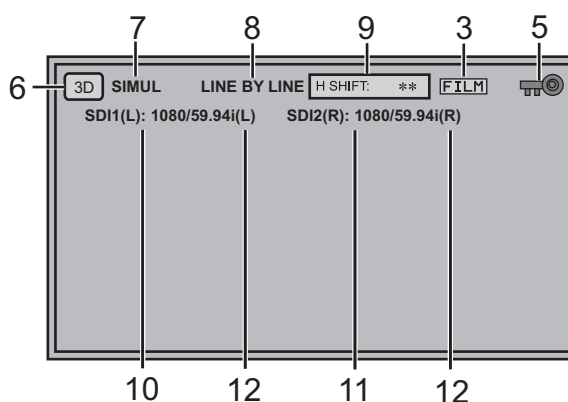

6. 3D display

- This indicates that "SYSTEM" is set to "3D" in the "3D" menu.

7. 3D INPUT TYPE display

- This indicates the "3D INPUT TYPE" of the "3D" menu

8. SIMUL MODE display

- This indicates the options for "SIMUL MODE" when "3D INPUT TYPE" is set to "SIMUL" in the "3D" menu.

9. H SHIFT display

- This is displayed when the "3D INPUT TYPE" of the "3D" menu is set to "SIMUL" and the SDI2 signal is being shifted horizontally using "H SHIFT".

10. SDI1 (L) display

- This indicates the format of the signal input from the SDI1 (L) terminal. When SIMUL is selected, synchronization is performed based on the left signal.

11. SDI2 (R) display

- This indicates the format of the signal input from the SDI2 (R) terminal. When SIMUL is selected, synchronization is performed based on the left signal.

12. (L)(R) display

- This displays left and right information when a signal that has left and right information superimposed (such as AG-3DA1) is input through SDI1.

If left and right input is mistakenly reversed, it is displayed in yellow.

Left and right information is not displayed if it is input through SDI2 only.

How to Use the On Screen Menu (continued)

Picture/volume adjusting menu

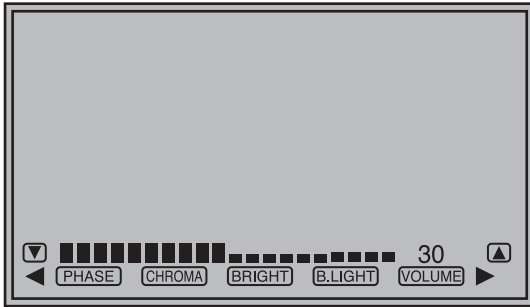

- Press the ADJUST button (→ page 13, **9**) to open the picture/volume adjusting menu.
- To clear the display, press the ADJUST button again, press the MENU button or leave it idle for 10 seconds.
- Only adjustments that appear on the screen can be adjusted.
- The display always appears in the same screen location.

Sharpness display

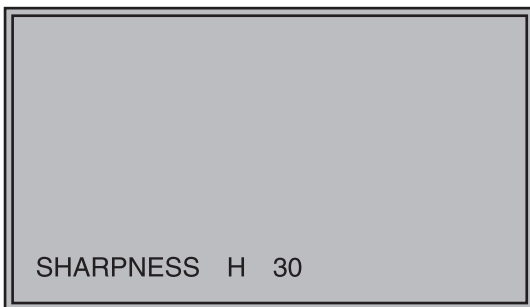

- This is the SHARPNESS H/V mode display.
- It disappears after 2 minutes of inaction.
- Displayed when setting SHARPNESS H in 3D mode.

FUNCTION display

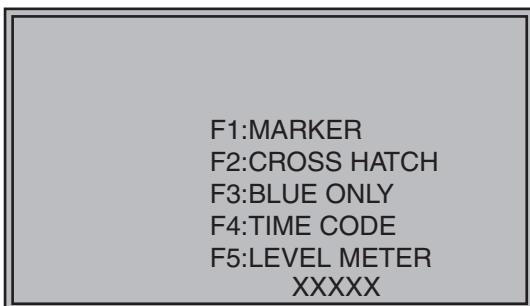

- Use the menu to open and set up functions.
- When “FUNCTION DISPLAY” (→ page 36) is set to “ON1” or “ON2”, pressing any of the “FUNCTION1” to “FUNCTION5” buttons displays the item and the status of the item for the respective FUNCTION.
- This display disappears after 2 seconds of inaction.
- “XXXXX” indicates operating status (→ page 38, “Functions and operating status displayed on screen when FUNCTION buttons are pressed”).

Audio level meter display

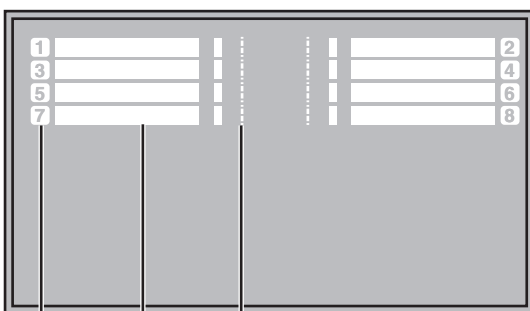

Channel display Level display 0 dB line

- A white skeleton bar meter indicates the audio level for SDI signals. When 3D mode is set to SIMUL, audio from the SDI signal input via SDI1 is always used.
- You can switch the level display on/off and set the number of displayed channels using the menu (→ page 42, “AUDIO”).
- The 0 dB line and channel display can be switched on/off from the menu (→ page 42, “AUDIO”).

Note:

When SDI2 and another input (except for a combination of SDI1 and SDI2) are used for the split screen display, TIME CODE and audio level meter display will not function. In this case, use SDI1.

How to Use the On Screen Menu (continued)

Menu display

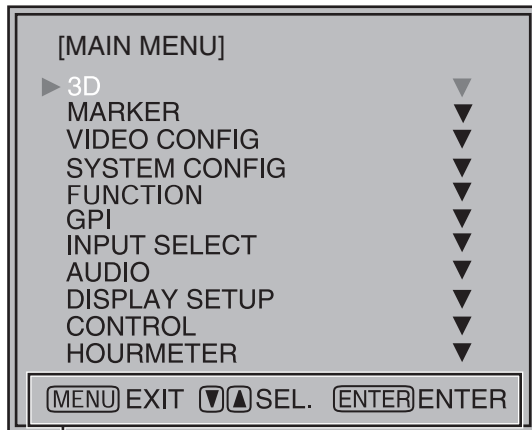

Displays instructions on menu button operations.

- This is the menu display.
- It disappears after 2 minutes of inaction.
- You can change position of the display (→ page 32, “MENU POSITION”).
- Options unavailable in 3D mode appear gray and cannot be selected.

TIME CODE display (TC)

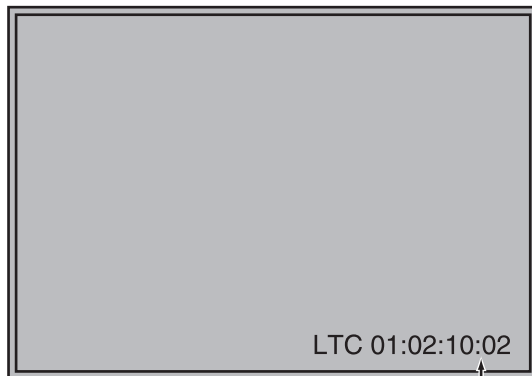

(:) NDF
(.) DF

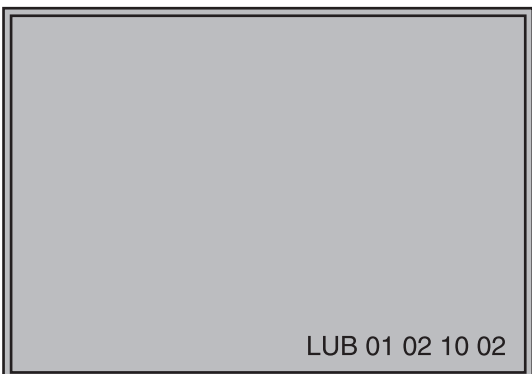

- Use the menu to display and set the time code for HD-SDI signal input. It also allows you to switch display mode (VITC, LTC, VUB, LUB).

In VITC and LTC display mode:

- Displays the time code in hours: minutes: seconds: or frames.
- In drop-frame mode, a different delimiter between seconds and frames is used.

Note:

- Read errors are displayed as “--:--:--:--”
- Displays the VITC/LTC of the HD SDI signal from SDI1 terminal when 3D mode is set to SIMUL.

In VUB and LUB display modes:

- BG8, BG7, BG6, BG5, BG4, BG3, BG2, BG1 appear in the stated order. BG: binary group
- The (:) delimiter does not appear.

Note:

- Read errors are displayed as “--:--:--:--”
- Displays the VUB/LUB of the HD SDI signal from SDI1 terminal when 3D mode is set to SIMUL.
- Display position and character size can be modified (→ page 43, “POSITION” and “FONT SIZE” in the “DISPLAY SETUP” menu).
- When SDI2 and another input (except for a combination of SDI1 and SDI2) are used for the split screen display, TIME CODE and audio level meter display will not function. In this case, use SDI1.

How to Use the On Screen Menu (continued)

CLOSED CAPTION (CC) display 2D ONLY

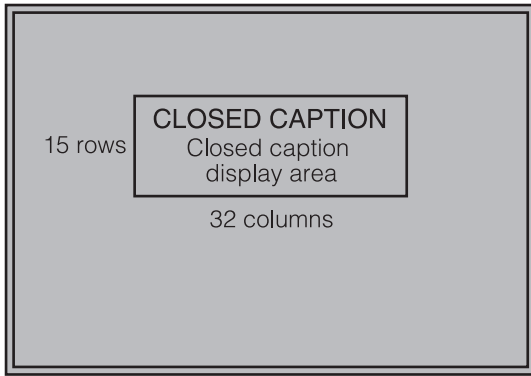

- Use the menu to display and set closed caption display for VIDEO (NTSC) signals. It also allows you to select display mode (CC1 to CC4) (→ page 43, “CLOSED CAPTION” and “MODE SELECT” in the “DISPLAY SETUP” menu.).

Note:

- Closed captions are not available during HV DELAY.
- In split-screen display, closed captions appear only when a VIDEO input line is displayed in the main window.

Menu operations

1. Press [MENU] to display the MAIN menu.

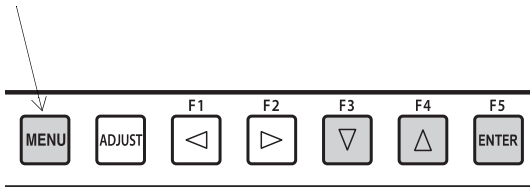

2. Press [▼, ▲] to select a menu and push [ENTER].

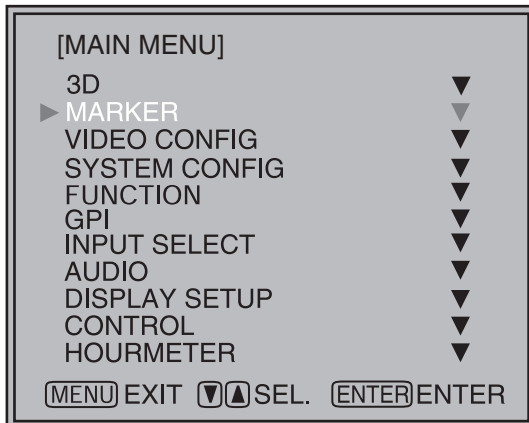

3. Press [▼, ▲] to select a sub menu and press [ENTER].

The settings in the sub menu change to green.

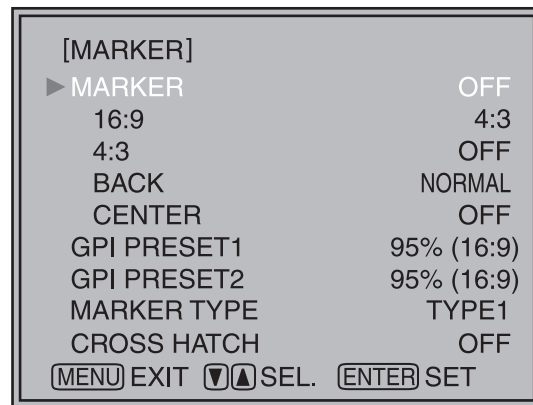

4. Press [▼, ▲] to select a setting, then press [ENTER].

To cancel, press [MENU].

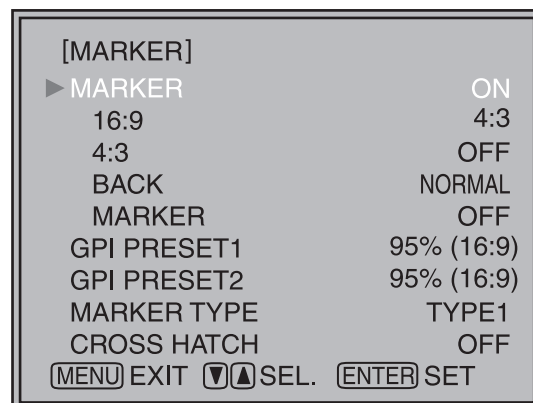

To return to the previous screen

Press the [MENU] button.

How to Use the On Screen Menu (continued)

Picture/volume adjusting menu operations

1. Press [ADJUST] to display the picture/volume adjusting menu.

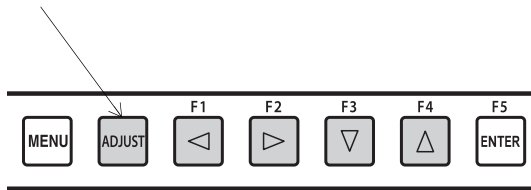

2. Press [◀, ▶] to select item to adjust.
The selected item changes to white.

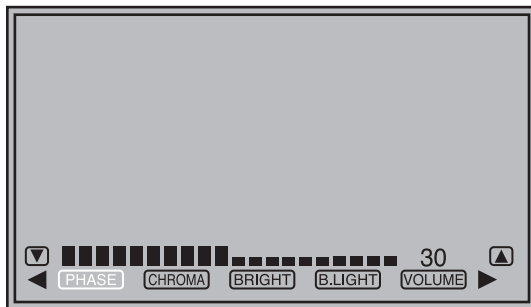

3. Press [▼, ▲] to adjust.

PHASE	0 - 60 (30)
CHROMA	0, 10 - 60 (30)
BRIGHT	0 - 60 (30)
B.LIGHT [BACKLIGHT]	0 - 60 (50)
VOLUME	0 - 60 (0)

() : Factory defaults

- Setting [B.LIGHT/CONT.] to CONT. [CONTRAST] in the [SYSTEM CONFIG] menu changes the B.LIGHT indication to CONT. enabling CONTRAST adjustment.

CONT. [CONTRAST] 0 - 60 (50)

- Adjustments are not possible under the following conditions.
 - When "CONTROL" in the "CONTROL" menu is set to "REMOTE," the key mark appears and adjustments cannot be changed.
 - Setting the MONO function to ON (→ page 30) disables the [PHASE] and [CHROMA] operations.
 - During "RGB-COMP." and "DVI-COMP." input, the [PHASE] and [CHROMA] operations are disabled.
 - During HV DELAY (→ page 37) operation (and a setting other than OFF is selected), [BRIGHT] operation is disabled.

4. Press [ADJUST] to end adjustments. The display is automatically closed after 10 seconds of inaction.

- The unit loads set values when the power is turned on. Changed values are automatically saved after 10 seconds.

User Data

You can save and load up to five combinations of menu settings and picture/volume adjustments as user data. You can also return settings and adjustments to their factory defaults.

User data include the following settings.

- Menu settings except “SETUP LOAD/SAVE” and “CONTROL/CONTROL” (including button function settings on the monitor front panel)
- Screen adjustments made in the picture/volume adjustments menu

Saving user data

1. Press [MENU] to display the MAIN menu.
2. Press [▼, ▲] to select the “SYSTEM CONFIG” menu and press [ENTER].
3. Press [▼, ▲] to select the “SETUP SAVE” sub menu and press [ENTER].

The setting in the sub menu changes to green.

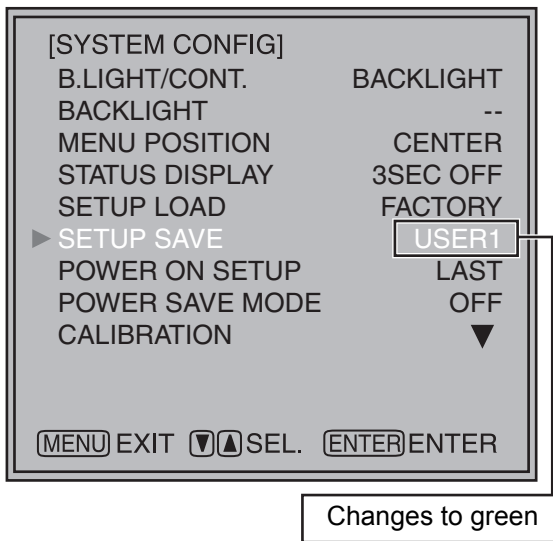

Changes to green

Loading user data

1. Press [MENU] to display the MAIN menu.
2. Press [▼, ▲] to select the “SYSTEM CONFIG” menu and press [ENTER].
3. Press [▼, ▲] to select the “SETUP LOAD” sub menu and press [ENTER].

The setting in the sub menu changes to green.

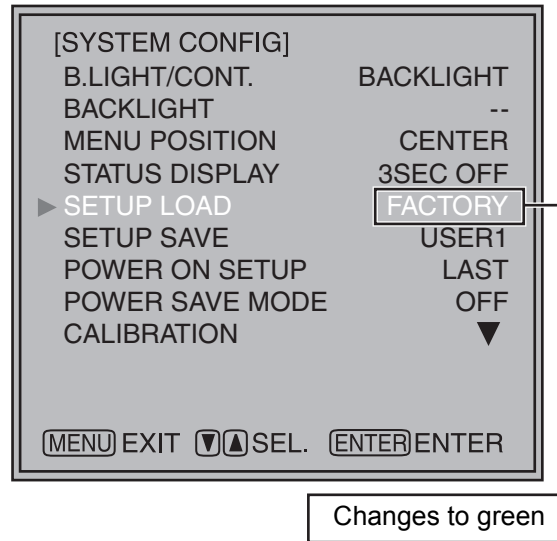

Changes to green

4. Press [▼, ▲] to select a “USER1” to “USER5” file to save the settings to and press [ENTER].

The following screen appears.

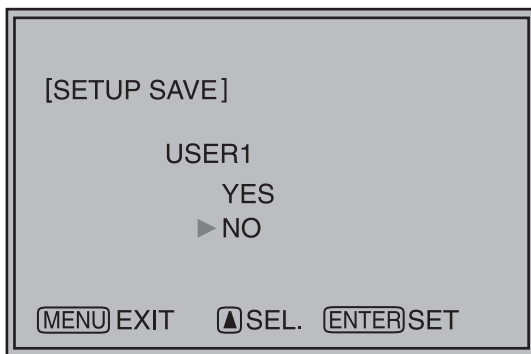

5. Select “YES” and press [ENTER].

This saves the user data.

4. Press [▼, ▲] to select a “USER1” to “USER5” file to load and press [ENTER].

The following screen appears.

To return to the factory defaults, select “FACTORY.”

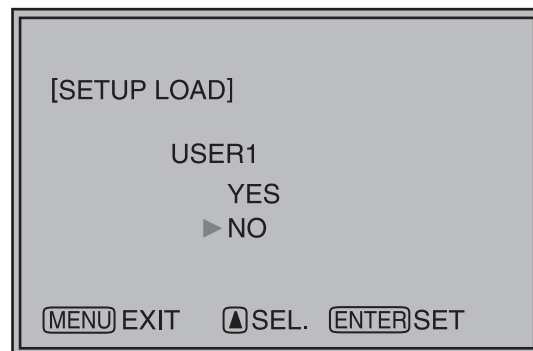

5. Select “YES” and press [ENTER].

This loads the user data.

To return to the previous screen

Push [MENU].

Main Menu

Menu configuration

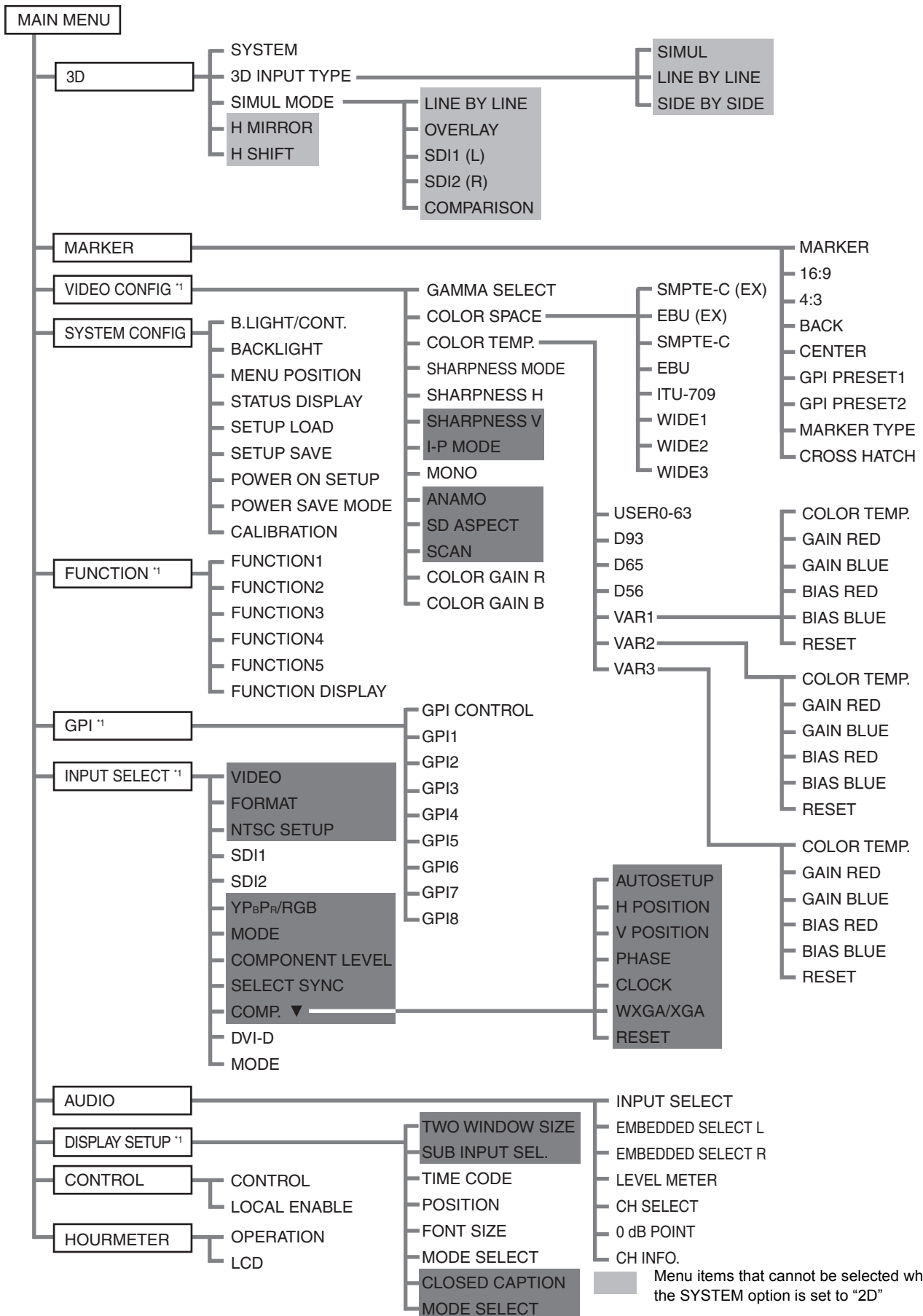

*1 Setting values can be stored for both 2D and 3D.

Menu items that cannot be selected when the SYSTEM option is set to "2D"

Menu items that are not available without being displayed when the SYSTEM option is set to "3D"

Main Menu (continued)

3D

Underlined values indicate factory defaults.

Sub menu	Setting	Description
SYSTEM	<u>3D</u> 2D	Switches between 2D and 3D <2D> Sets monitor to work in 2D mode <3D> Sets monitor to work in 3D (spectroscopic) mode
3D INPUT TYPE 3D ONLY	<u>SIMUL</u> LINE BY LINE SIDE BY SIDE	Selects the input type in 3D mode. <SIMUL> Uses the signals input from SDI1 and SDI2. Ensure that the left-eye signal (L) is connected to SDI1, and the right-eye signal is connected to SDI2 (R). When this input type is selected, the SIMUL MODE noted below becomes active. When SIMUL is selected the input signal from SDI1 is used as the base and a phase difference of up to 15 μ s with the SDI2 input signal is allowed. <LINE BY LINE> Uses a signal with the left-eye and right-eye signals split line by line. <SIDE BY SIDE> The left-eye signal is displayed on the left hand side of the screen, the right-eye signal on the right side of the screen. A horizontally time compressed signal is used for both.
SIMUL MODE 3D ONLY	<u>LINE BY LINE</u> OVERLAY SDI1(L) SDI2(R) COMPARISON	Selects the display method when SIMUL is selected. <LINE BY LINE> Displays in 3D (stereoscopic). <OVERLAY> Mixes and displays the left-eye and right-eye signals. <SDI1(L)> Displays only the signal from SDI1 <SDI2(R)> Displays only the signal from SDI2 <COMPARISON> Displays the signal input from SDI1 on the left side of the screen, and the signal input from SDI2 on the right side of the screen. Both images are the same size and the aspect ratio is 16:9. The MARKER function is unavailable.
H MIRROR 3D ONLY	<u>OFF</u> ON	This option horizontally inverts the signal from SDI2 when "LINE BY LINE" or "OVERLAY" is selected in SIMUL mode. This can be used when checking left/right signals. <OFF> Signal not inverted. <ON> Signal inverted.
H SHIFT 3D ONLY	-128 - 127 (Factory default: 0)	Shifts the SDI2 signal horizontally when <LINE BY LINE> or <OVERLAY> is selected in SIMUL mode. The value of this setting is retained until the power is turned off. It is reset to "0" when the power is turned off and then on again.

Main Menu (continued)

MARKER

Not available in the split-screen display of the "TWO WINDOW" function or COMPARISON in 3D mode. (CROSS HATCH is not affected.)

Underlined values indicate factory defaults.

Sub menu	Setting	Description
MARKER	<u>OFF</u> * ¹ ON	Turns the MARKER setting on and off. <OFF> MARKER disabled <ON> MARKER available
16:9 * ² * ³ * ⁴	<u>OFF</u> 4:3 13:9 14:9 CNSCO VISTA 95% 93% 90% 88% 80% USER 85%	Selects/displays the 16:9 marker type. <OFF> No marker display <4:3> 4:3 marker <13:9> 13:9 marker <14:9> 14:9 marker <CNSCO> CNSCO marker <VISTA> VISTA marker <95%> 95% area marker <90%> 90% area marker <80%> 80% area marker <93%> 93.1% area marker (TYPE1) 93% area marker (TYPE2) <88%> 89.5% area marker (TYPE1) 88% area marker (TYPE2) <USER> This area marker can be varied in 1% increments in the range between 80% to 100%. However, an 88% value for a TYPE1 MARKER TYPE indicates an area marker whose height is 89% of available screen height in the selected aspect ratio. (The factory default is 85%.)
4:3 * ² * ⁴	<u>OFF</u> 95% 93% 90% 88% 80% USER 85%	Selects/displays the 4:3 marker type. <OFF> No marker display <95%> 95% area marker <93%> 93% area marker <90%> 90% area marker <80%> 80% area marker <88%> 89% area marker (TYPE1) 88% area marker (TYPE2) <USER> This area marker can be varied in 1% increments in the range between 80% to 100%. Values of 93% and 88% for TYPE1 MARKER TYPE indicate area markers whose height is 93.1% and 89.5%, respectively, of available screen height in the selected aspect ratio. (The factory default is 85%.)
BACK * ²	<u>NORMAL</u> HALF BLACK	Selects the background brightness around the marker. <NORMAL> Normal background <HALF> 50% background brightness <BLACK> 0% background brightness (black)
CENTER * ²	<u>OFF</u> ON	Displays/turns off the center marker. <OFF> Turns the display off <ON> Turns the display on

*1 This setting is turned "ON" when receiving marker control in REMOTE operation. (GPI, if set, has priority.)

*2 These settings are disabled when the GPI function (→ page 53) is used to control the marker setting. They are also disabled in split screen mode.

*3 This setting is enabled only for HD and SD signal input in 16:9 aspect ratio mode.

*4 TYPE1 and TYPE2 area marker size depends on the "MARKER TYPE" setting (→ page 26).

Main Menu (continued)

Sub menu	Setting	Description
GPI PRESET1 *1	4:3 13:9 14:9 CNSCO VISTA	GPI PRESET1: Selects the marker displayed by the GPI terminal "MARKER1 ON/OFF" (→ page 53) operation. GPI PRESET2: Selects the marker displayed by the GPI terminal "MARKER2 ON/OFF" (→ page 53) operation.
GPI PRESET2 *1	95% (16:9) 93% (16:9) 90% (16:9) 88% (16:9) 80% (16:9) USER (16:9) 95% (4:3) 93% (4:3) 90% (4:3) 88% (4:3) 80% (4:3) USER (4:3)	<4:3> 4:3 marker <13:9> 13:9 marker <14:9> 14:9 marker <CNSCO> CNSCO marker <VISTA> VISTA marker <95% (16:9)> 95% area marker for 16:9 aspect ratio <93% (16:9)> 93% area marker for 16:9 aspect ratio <90% (16:9)> 90% area marker for 16:9 aspect ratio <88% (16:9)> 88% area marker for 16:9 aspect ratio <80% (16:9)> 80% area marker for 16:9 aspect ratio <95% (4:3)> 95% area marker for 4:3 aspect ratio <93% (4:3)> 93% area marker for 4:3 aspect ratio <90% (4:3)> 90% area marker for 4:3 aspect ratio <88% (4:3)> 88% area marker for 4:3 aspect ratio <80% (4:3)> 80% area marker for 4:3 aspect ratio <USER> Displays using the USER value of 16:9 / 4:3.
MARKER TYPE *2*3	TYPE2 TYPE1	Selects conventional monitor or camera recableer marker size. <TYPE2> Marker size compliant with the camera recorder (Panasonic) <TYPE1> The marker has the same size as that of the previous model (BT-LH2600W).
CROSS HATCH	OFF LOW HIGH	Turns the cross hatch grid on and off and sets its density. <OFF> Turns the display off <LOW> 20/256 gradations (displays a light cross hatch grid) <HIGH> 70/256 gradations (displays a dense cross hatch grid)

*1 Remote control via RS-232C ends in error (error response: ER001) when "GPI PRESET1" or "GPI PRESET2" is selected with the GPI function.

*2 TYPE1 and TYPE2 area marker size depends on the "MARKER TYPE" setting.

*3 Display size for SD signals differ.

TYPE1: The effective horizontal area meets the SMPTE125M for NTSC and ITU-R BT. 601-5 for PAL.

TYPE2: The effective horizontal area meets the EIA-RS170A for NTSC and ITU-R BT. 470-4 for PAL.

Main Menu (continued)

Marker types

16:9 marker (Displayed for HD input and SD input in 16:9 ratio mode.)

This marker is only displayed as a vertical bar. The  section becomes the "MARKER BACK".

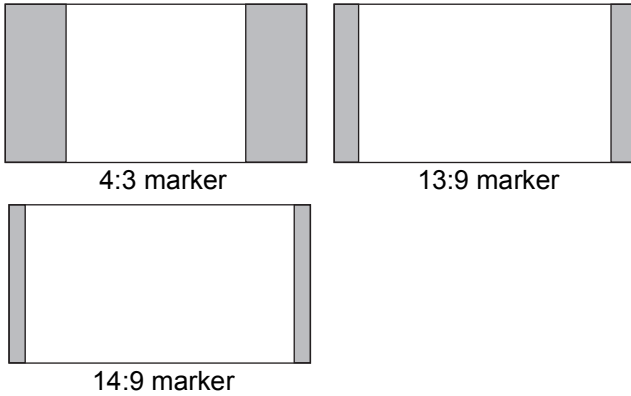

VISTA marker, CNSCO marker

This marker is displayed as a horizontal dotted line.

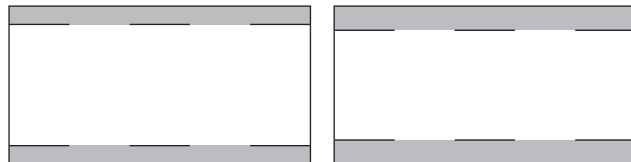

The marker is displayed as a vertical dotted line when "UNDER" is selected under "SCAN" in the "VIDEO CONFIG" menu.

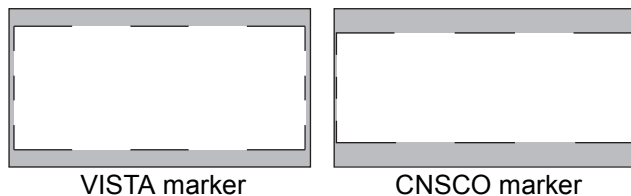

Area marker

This marker is displayed as a dotted line.

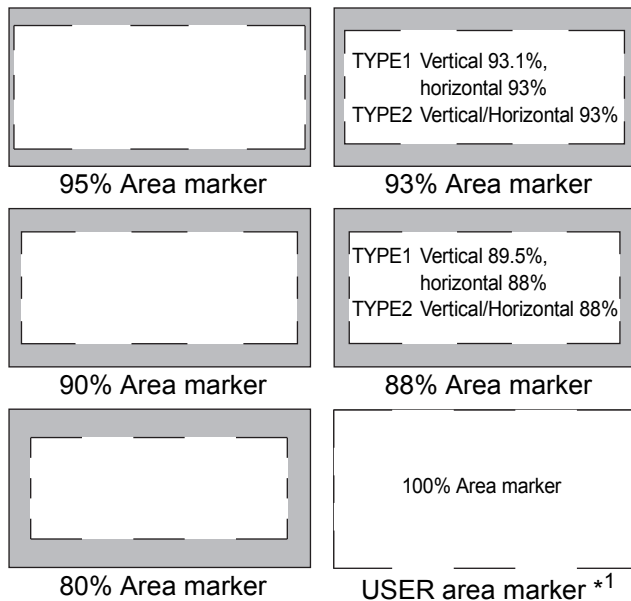

*1 Use the ▼ and ▲ buttons to increase or decrease the area marker in 1% increments in the range between 80 and 100%.

4:3 marker (Displayed for SD input in 4:3 aspect ratio mode)

This marker is displayed as a dotted line.

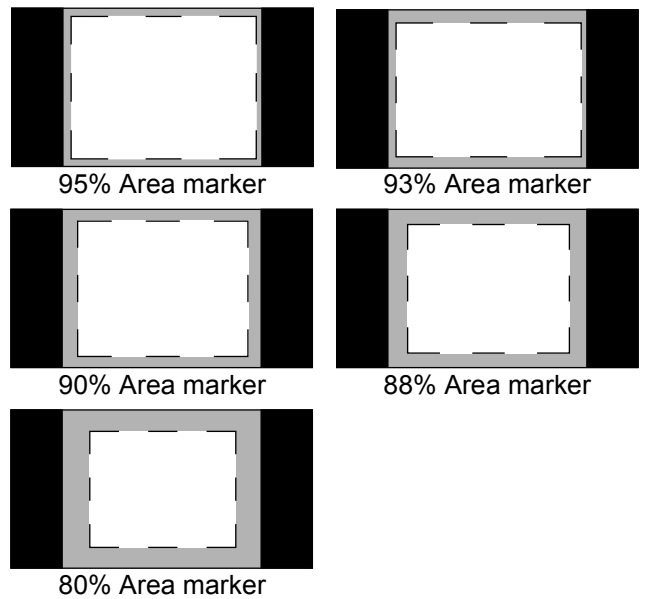

(Displayed for HD input and SD input in 16:9 ratio mode.)

This marker is displayed as a dotted line.

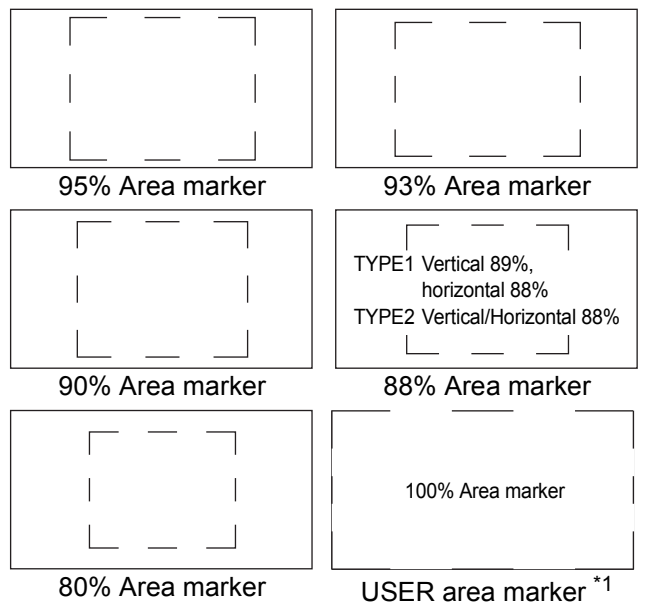

You can display the 4:3 marker and the 16:9 marker simultaneously.

Simultaneous display example

The  section becomes the "MARKER BACK". It controls the background of the marker selected with a 16:9 ratio.

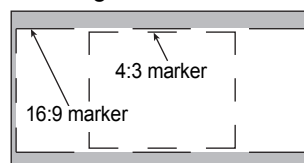

16:9 marker:
95% area marker
4:3 marker:
80% area marker

Center marker

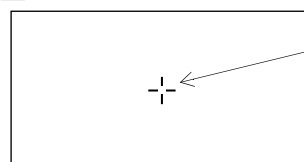

Center marker
This marker is displayed at the center of the screen.

Main Menu (continued)

■ “CROSS HATCH”

The “CROSS HATCH” function enables display of markers at regular vertical and horizontal intervals to facilitate composition and other tasks. The width of marker lines is 1 dot, the markers consist of 1 line, and are spaced 120 dots apart (fixed value).

Each press of the button (“FUNCTION1” to “FUNCTION5”) to which the “CROSS HATCH” has been assigned turns the function on and off.

Note:

The CROSS HATCH signal displays vertical lines at intervals of 6% of the width of the screen.

Each press of the FUNCTION button to which the “CROSS HATCH” function is assigned changes the display as shown.

HD/SD (16:9) mode



1st press

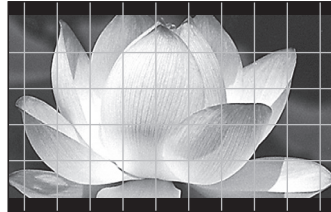

2nd press

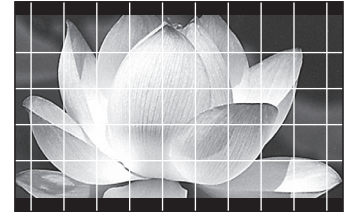

SD (4:3) mode



Light cross hatch

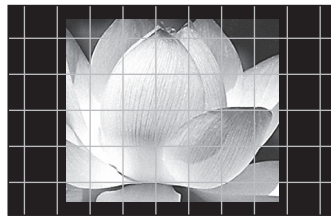

Dense cross hatch

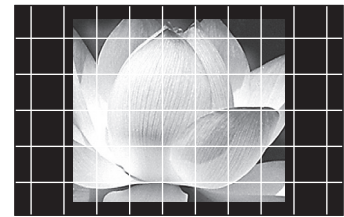

3rd press (back to original image without cross hatch)



Main Menu (continued)

VIDEO CONFIG

Underlined values indicate factory defaults.

Sub menu	Setting	Description
GAMMA SELECT *1*2	<u>STANDARD</u> <u>STDIO/PST</u> FILM	Selects gamma curve. The gamma curve in the sub-window can be set in the split-screen display and sub-window display (single screen) of the "TWO WINDOW" function. <STANDARD> Standard mode <STDIO/PST> Color emphasis mode (a mode that approximates CRT display capability suitable for studio or postproduction application) <FILM> Film mode (For VARICAM use) The FILM mark appears at the top left of the screen when "FILM" is selected.
COLOR SPACE *7*8	<u>SMPTE-C (EX)</u> <u>EBU (EX)</u> SMPTE-C EBU ITU-709 WIDE1 WIDE2 WIDE3	Sets the color space. The color space in the sub-window can be set in the split-screen display and sub-window display (single screen) of the "TWO WINDOW" function. <SMPTE-C (EX)> Redness changed from <SMPTE-C> mode. *9 <EBU (EX)> Redness changed from <EBU> mode. *9 <SMPTE-C> SMPTE-C standard <EBU> EBU standard <ITU-709> ITU-R BT. 709 standard <WIDE1> Sets the gamma curve to 2.2 in wide color gamut (using Adobe color space) mode. <WIDE2> Sets the gamma curve to 1.8 in wide color gamut (using Adobe color space) mode. <WIDE3> Sets the gamma curve to 2.6 in wide color gamut (using D-Cinema color space) mode.
COLOR TEMP.	<u>USER0 - 63</u> *5*6 <u>D93</u> *6 <u>D65</u> *6 <u>D56</u> *6 VAR1 VAR2 VAR3	Selects color temperature. Both the main window and sub-window can be set up in the split-screen display of the "TWO WINDOW" function. <USER 0 - 63> Adjustable settings 0 - 63 (equivalent to a color temperature range of 3,000 - 9,300K) <D93> Equivalent to a color temperature of 9,300K <D65> Equivalent to a color temperature of 6,500K <D56> Equivalent to a color temperature of 5,600K <VAR1> WB adjustment mode *4 <VAR2> WB adjustment mode *4 <VAR3> WB adjustment mode *4 USER20 is approximately 5,000 K and USER33 is approximately 6,300 K.
SHARPNESS MODE *2	<u>HIGH</u> *3 LOW	Selects the width of outline correction edge. Both the main window and sub-window can be set up in the split-screen display of the "TWO WINDOW" function. <HIGH> Thin edge <LOW> Wide edge

*1 Changes are not reflected to a still image in the main window in the split-screen display of the "TWO WINDOW" function.

*2 These functions are not available when "RGB-COMP." under "YPbPr/RGB" or "DVI-COMP." under "DVI-D" is selected in the "INPUT SELECT" menu (→ page 40). The gamma curve is set to STANDARD when "RGB-COMP." or "DVI-COMP." is selected. Selecting WIDE1 to 3 for "COLOR SPACE" produces the gamma curve fixed to that "COLOR SPACE."

*3 The following sharpness values are available and the settings for the selected input signal is displayed. Adjustment status during selection appears at the bottom right of the screen.

1) VIDEO system input (VIDEO) (the factory defaults are SHARPNESS MODE: LOW)

2) HD for any other input (the factory defaults are SHARPNESS MODE: HIGH).

3) SD for any other input (the factory defaults are SHARPNESS MODE: LOW).

*4 Selecting "VAR1", "VAR2" and "VAR3" engages the WB adjustment mode (→ page 31).

*5 Procedure for selecting USER 0 - 63:

1) Press [ENTER] ("USER" changes to blue). 2) Use [**▼**, **▲**] to select 0 - 63 and press [ENTER].

6 An asterisk () is displayed after the color temperature value in 3D mode. (Example display: D65*) This indicates that it is an adjusted value for when using 3D Polarized Eyewear.

*7 Factory default setting: SMPTE-C (U.S.A. and Canada), EBU (other countries)

*8 The SD11 signal and SDI2 signal (displayed when "COMPARISON" is selected in SIMUL MODE) are set to the same color space.

*9 As the red reproduction of this monitor is truer to the original than previous models (exc. BT-LH2550) red appears darker. Used when rendering colors that have a softer shade of red.

Main Menu (continued)

Sub menu	Setting	Description
SHARPNESS H *1	<u>0</u> - 30	Sets horizontal outline correction. The item display moves to the lower part of the screen during adjustment. Both the main window and sub-window can be set up in the split-screen display of the “TWO WINDOW” function.
SHARPNESS V *1 2D ONLY	<u>0</u> - 30	Sets vertical outline correction. The item display moves to the lower part of the screen during adjustment. Both the main window and sub-window can be set up in the split-screen display of the “TWO WINDOW” function.
I-P MODE *1*2 2D ONLY	MODE2 <u>MODE1</u>	Selects IP conversion mode. (→ page 30, “IP mode”) Both the main window and sub-window can be set up in the split-screen display of the “TWO WINDOW” function. <MODE2> Inter-field interpolation <MODE1> Inter-frame interpolation
MONO *1	<u>OFF</u> ON	Switches between color and monochrome (MONO). <OFF> Color <ON> Monochrome • When ON, the CHROMA setting of the picture/volume adjusting menu is fixed at 0.
ANAMO *1*3 2D ONLY	<u>OFF</u> ON	With an Anamo lens and HD-SDI input, the picture is resized to Anamo magnification (the vertically enlarged signal can be vertically compressed and corrected for display). Can be set in the split screen display of the “TWO WINDOW” function, but operation is disabled.
SD ASPECT *1 2D ONLY	<u>4:3</u> 16:9	Sets the aspect ratio for SD signal input. Can be set in the split screen display of the “TWO WINDOW” function, but operation is disabled. <4:3> 4:3 display <16:9> 16:9 display
SCAN *1 2D ONLY	<u>NORMAL</u> UNDER	Sets under-scan and normal display. Can be set in the split screen display of the “TWO WINDOW” function, but operation is disabled. <NORMAL> Normal display <UNDER> Under-scan
COLOR GAIN R	0 - <u>30</u>	This fine tunes the GAIN of the R component. The R component of the sub-window can be set in the split-screen display and sub-window display (single screen) of the “TWO WINDOW” function in 2D mode. In 3D mode (COMPARISON), the R component of SDI2 (R) can be set.
COLOR GAIN B	0 - <u>30</u>	This fine tunes the GAIN of the B component. The B component of the sub-window can be set in the split-screen display and sub-window display (single screen) of the “TWO WINDOW” function in 2D mode. In 3D mode (COMPARISON), the B component of SDI2 (R) can be set.

*1 These functions are not available when “RGB-COMP.” under “YP_BP_R/RGB” or “DVI-COMP.” under “DVI-D” is selected in the “INPUT SELECT” menu (→ page 40).

*2 To use the “TWO WINDOW” (→ page 44) function,
1) Change settings after exiting the “TWO WINDOW” function.
2) It is recommended to use “MODE2” for handling fast video.

*3 “SCAN” changes are not reflected in Anamo size display.

<p>IP mode “MODE1” performs IP conversion using inter-frame interpolation. The factory default is “MODE1”.</p> <p>“MODE2” performs IP conversion using inter-field interpolation. Since interpolation is performed inside each field, this mode is suitable for checking interlace status.</p>

Main Menu (continued)

WB adjustment mode

Select "VAR1" to "VAR3" for "COLOR TEMP." in the "VIDEO CONFIG" menu to make "WHITE BALANCE VAR1" to "WHITE BALANCE VAR3" (WB) adjustments.

Underlined values indicate factory defaults.

Sub menu	Settings	Description
COLOR TEMP. *1	USER 0 - 63 D93 *3 <u>D65</u> *3 D56 *3	Selects the color temperature that will become the basis for adjustment. <USER 0 - 63> Adjustable settings 0 - 63 (equivalent to a color temperature range of 3,000 - 9,300K) <D93> Equivalent to a color temperature of 9,300K <D65> Equivalent to a color temperature of 6,500K <D56> Equivalent to a color temperature of 5,600K USER20 is approximately 5,000 K and USER33 is approximately 6,300 K.
GAIN RED	0 - 1023 (Factory defaults are color temperature <D65> values.)	Adjusts the GAIN elements for RED. *2
GAIN BLUE	•These are the adjustments made before shipment from the factory.	Adjusts the GAIN elements for BLUE. *2
BIAS RED	-512 - 511	Adjusts the BIAS elements for RED. *2
BIAS BLUE	(Factory default: 0)	Adjusts the BIAS elements for BLUE. *2
RESET	▼	Resets "GAIN RED" - "BIAS BLUE" to color temperature values selected under "COLOR TEMP."

*1 Selecting "COLOR TEMP." and pressing [ENTER] after making a change, opens a confirmation screen.

Selecting "YES" and pressing [ENTER] in this screen resets selected GAIN and BIAS values to the selected color temperature values.

*2 The item display moves to the lower part of the screen during adjustment.

3 An asterisk () is displayed after the color temperature value in 3D mode. (Example display: D65*) This indicates that it is an adjusted value for when using 3D Polarized Eyewear.

Main Menu (continued)

SYSTEM CONFIG

Underlined values indicate factory defaults.

Sub menu	Settings	Description
B.LIGHT/CONT.	<u>BACKLIGHT</u> CONTRAST	Selects function to be assigned to BACKLIGHT/CONT. in the picture/volume adjusting menu. <BACKLIGHT> Adjusts the BACKLIGHT. <CONTRAST> Adjusts the CONTRAST.
BACKLIGHT	0 - <u>50</u> - 60	Adjusts the backlight when the B.LIGHT/CONT. submenu is set to CONTRAST.
MENU POSITION	<u>CENTER</u> LB RB RT LT	Positions the on-screen menu. <CENTER> Center of the screen <LB> Left Bottom <RB> Right Bottom <RT> Right Top <LT> Left Top
STATUS DISPLAY	OFF <u>3SEC OFF</u> *3 <u>CONTINUE</u>	Sets display state for input signal status (on-screen menu). <OFF> Not displayed. <3SEC OFF> Displayed for 3 seconds after a status change. <CONTINUE> Displayed at all times
SETUP LOAD	USER5 *1*2 USER4 *1*2 USER3 *1*2 USER2 *1*2 USER1 *1*2 <u>FACTORY</u>	Loads saved factory defaults (FACTORY) or user data (USER1 - USER5). After loading user data, the screen displays the signal selected before user data was loaded.
SETUP SAVE	USER5 *2 USER4 *2 USER3 *2 USER2 *2 <u>USER1</u> *2	Up to 5 sets of user data can be saved (→ page 22). They save menu settings and adjustments made in the picture/volume adjusting menu (PHASE/CHROMA/BRIGHT/CONTRAST/BACKLIGHT) except "SETUP SAVE/SETUP LOAD."
POWER ON SETUP	USER5 USER4 USER3 USER2 USER1 FACTORY <u>LAST</u>	Selects the settings used when the power is turned on. <LAST> Starts in the mode used when the power was last turned off. <FACTORY> Starts up using the factory defaults. <USER1 - 5> Starts up using USER registered settings.
POWER SAVE MODE	<u>OFF</u> ON	Sets the power save mode <OFF> Does not activate the POWER SAVE mode. <ON> The backlight dims when no signal (NO SIGNAL) is input for 60 seconds or longer. Signal input or menu operation will return the backlight to its normal brightness.
CALIBRATION	▼	Connect a CA-210 color analyzer and use this submenu to make a calibration. It also returns calibration data to factory defaults. (→ page 33, 34)

*1 When the monitor is shipped, settings for "USER1" - "USER5" are identical to "FACTORY."

*2 "H SHIFT" (→ page 24), "H POSITION", "V POSITION", "PHASE" and "CLOCK" (→ page 41) cannot be saved or loaded.

*3 So that there is no confusion with 2D mode when working in 3D mode, STATUS DISPLAY will display information as per the "CONTINUE" setting even if "3SEC OFF" is selected.

Main Menu (continued)

■ CALIBRATION

The CALIBRATION function in this unit measures LCD panel characteristics from low to high brightness values and internal monitor processing handles CALIBRATION.

CALIBRATION does not rely on image quality settings since internal signals are used for a calibration.

CALIBRATION in this unit is made at D65 color temperature and calibrations for other color temperatures are results calculated from this value.

■ Equipment required for calibration

- Konica Minolta CA-210 display color analyzer
 - Konica Minolta CA-PU12 or CA-PU15 standard measurement probe
 - RS-232C cable (male to male, straight)
- Connect the RS-232C terminal on this unit to the RS-232C terminal on the CA-210 display color analyzer using a straight cable.

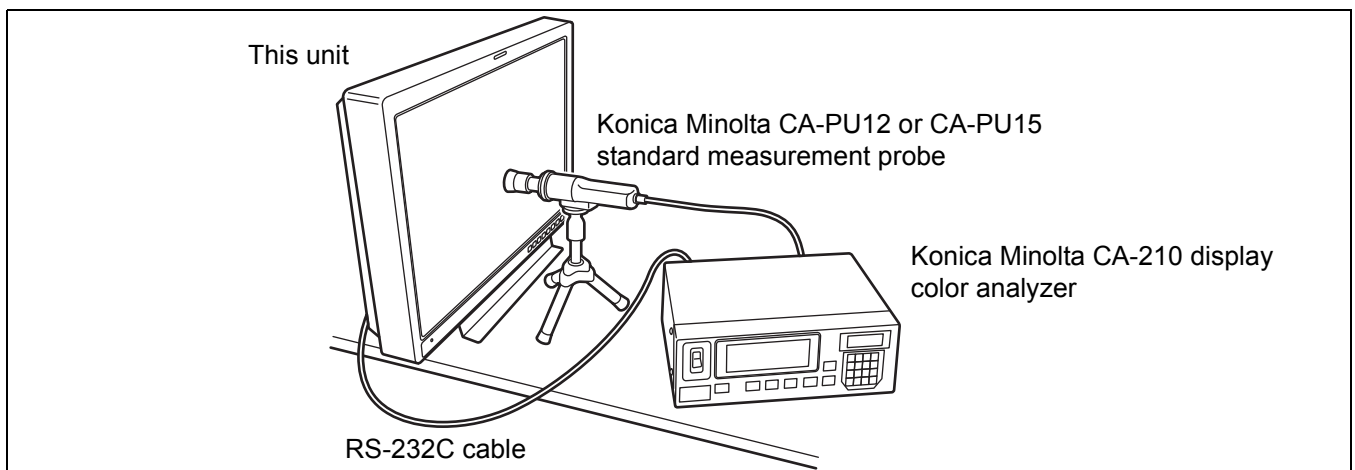
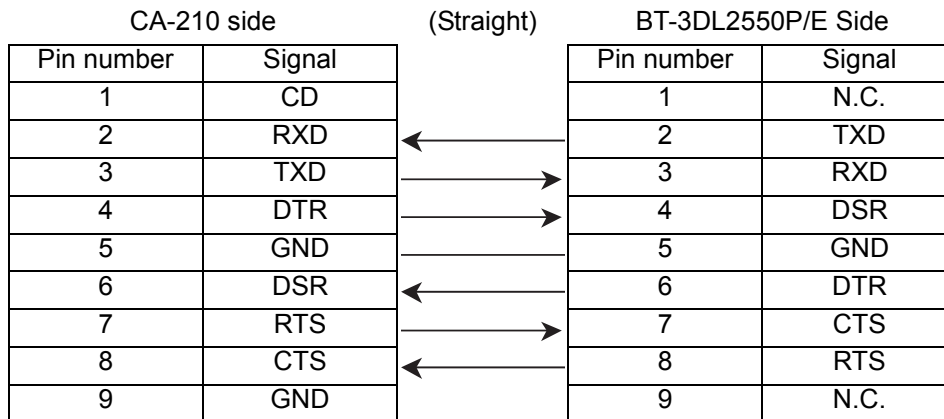

- Be sure to set the following calibration values on the CA-210 display color analyzer. The analyzer will not produce a correct calibration unless it has been calibrated. For details on setup procedures, refer to the CA-210 User's Guide.

Calibration	W	R	G	B
x	0.3091	0.6759	0.2029	0.1495
y	0.3429	0.3126	0.691	0.0587
Lv	195.3	47.56	135.2	13.21

- Turn on this unit and perform adequate aging (about 1 hour) before starting calibration.
- Turn off the lights in the room and make sure that no external light can enter the standard measurement probe before starting the calibration. External light that enters the probe will prevent correct calibration of low brightness characteristics.
- LCD panel characteristics and instrument error in the display color analyzer may sometimes result in small differences in values after calibration.
In a fine tuning of the monitor, also set GAIN and BIAS for R and B in the COLOR TEMP. VAR mode. The GAIN and BIAS values for G cannot be altered.
- Do not place 3D Polarized Eyewear between the analyzer and the monitor during calibration.

Main Menu (continued)

■ CALIBRATION

Select CALIBRATION in the “SYSTEM CONFIG” menu to open the following menus.

Sub menu	Setting	Description
AUTO CALIBRATION *1	▼	Connect a CA-210 color analyzer and use this submenu to make a calibration. Select “AUTO CALIBRATION” and select “YES” in the confirmation screen that appears to start calibration.
RESET *2	▼	Returns calibration data to their factory defaults. Select “RESET” and select “YES” in the confirmation screen that appears to return calibrated values to their factory defaults.

*1 “EXECUTING” is displayed during “AUTO CALIBRATION” and “COMPLETE” appears when calibration ends.
“INCOMPLETE” appears if calibration could not be completed.

*2 When “RESET” ends, “COMPLETE” appears.

Performing AUTO CALIBRATION

1. Press [▼, ▲] in the “SYSTEM CONFIG” menu, select the [CALIBRATION] submenu and press [ENTER].
2. Press [▼, ▲], select the [AUTO CALIBRATION] submenu and press [ENTER].

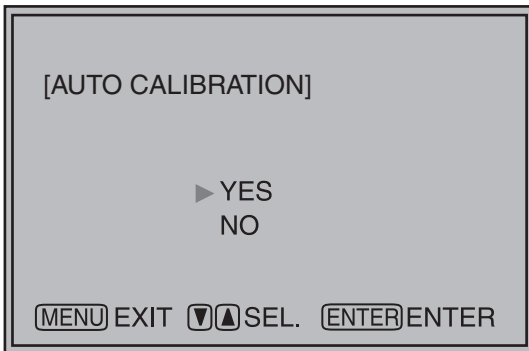

3. Select “YES” and press [ENTER].
This starts calibration.

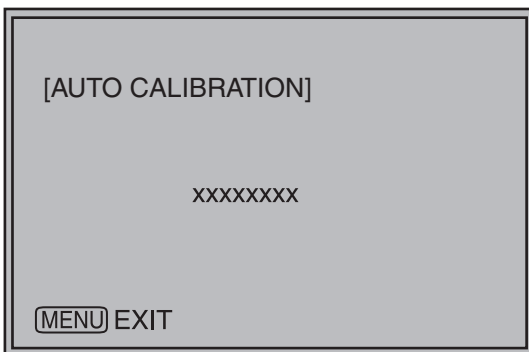

xxxxxxx indicates that one of the following messages with the meaning listed below appears.

EXECUTING: Operation in progress
COMPLETE: Operation completed
INCOMPLETE: Operation did not complete.
(Check RS-232C cable connection.)

RESET operation

1. Press [▼, ▲] in the “SYSTEM CONFIG” menu, select the [CALIBRATION] submenu and press [ENTER].
2. Press [▼, ▲], select the [RESET] submenu and press [ENTER].

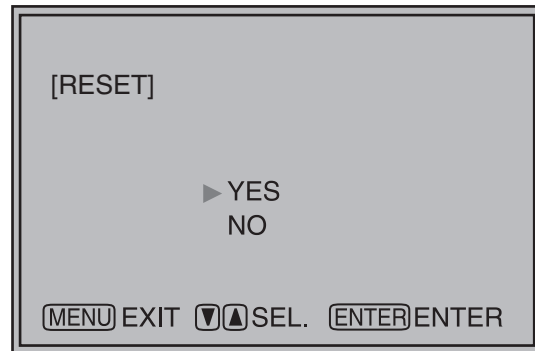

3. Select “YES” and press [ENTER].
This resets the setting of this monitor.

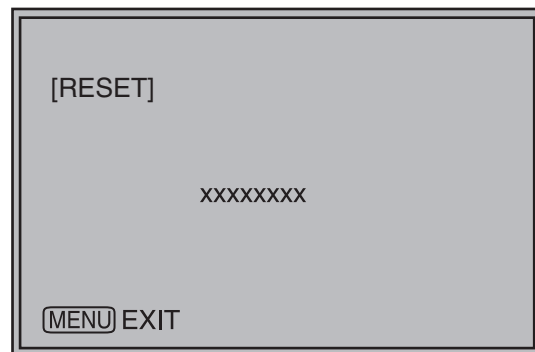

xxxxxxx indicates that the following message with the meaning listed below appears.

COMPLETE: Operation completed

Main Menu (continued)

FUNCTION

Underlined values indicate factory defaults.

Sub menu	Settings	Description
FUNCTION 1 - FUNCTION 5	HV DELAY AUTOSETUP BLUE ONLY GAMMA SELECT COLOR SPACE SD ASPECT SCAN TWO WINDOW SUB INPUT SEL. MARKER LEVEL METER CROSS HATCH MONO TIME CODE CLOSED CAPTION ANAMO 3D INPUT TYPE SIMUL MODE H MIRROR UNDEF (Factory defaults, same in 2D mode and 3D mode) FUNCTION1: MARKER FUNCTION2: CROSS HATCH FUNCTION3: BLUE ONLY FUNCTION4: TIME CODE FUNCTION5: LEVEL METER	Selects functions to be assigned to [FUNCTION1] - [FUNCTION5] (front panel buttons). <HV DELAY> 2D ONLY Displays synchronizing signals (horizontal, vertical). The display changes in the following order. DELAY OFF → H DELAY → V DELAY → HV DELAY → DELAY OFF <AUTOSETUP> 2D ONLY Performs auto setup for PC display. <BLUE ONLY> Cuts the red and green signals. Use this function to check phase and chroma. This button toggles between ON and OFF. <GAMMA SELECT>*1 Displays the gamma curve. The display changes in the following order. GAMMA STANDARD → GAMMA FILM → GAMMA STUDIO/PST → GAMMA STANDARD <COLOR SPACE> Sets the color space. The display changes in the following order. EBU → ITU-709 → WIDE1 → WIDE2 → WIDE3 → SMPTE-C (EX) → EBU (EX) → SMPTE-C → EBU <SD ASPECT> 2D ONLY Switches between "16:9" and "4:3."*1 <SCAN> 2D ONLY Switches between "UNDER SCAN" and "NORMAL SCAN".*1 <TWO WINDOW> 2D ONLY Sets the split-screen function.*1 The display changes in the following order. • When the input signal terminals of video displayed in the sub-window and main window differ SINGLE MAIN → TWO (L/S, M/M, S/L) → SINGLE SUB → SINGLE MAIN • When video from the same input signal terminal is displayed in the sub-window and main window SINGLE MAIN → TWO(L/S, M/M, S/L) → STILL → SINGLE SUB → SINGLE MAIN <SUB INPUT SEL.> 2D ONLY Switches sub-window inputs in split screen mode. <MARKER> Turns the marker on and off. <LEVEL METER> Turns the LEVEL METER display on and off. <TIME CODE> Turns the time code display on and off. <MONO> Switches between color and monochrome. <CLOSED CAPTION> 2D ONLY Turns the closed caption display on and off. <ANAMO> 2D ONLY Turns ANAMO on and off.

*1 Changes in settings change menu settings.

Main Menu (continued)

Sub menu	Settings	Description
FUNCTION 1 - FUNCTION 5		<p><3D INPUT TYPE> 3D ONLY Selects the input type in 3D mode. SIMUL → LINE BY LINE → SIDE BY SIDE</p> <p><SIMUL MODE> 3D ONLY Selects the display method in “SIMUL” mode. LINE BY LINE → OVERLAY → SDI1(L) → SDI2(R) → COMPARISON</p> <p><H MIRROR> 3D ONLY Selects whether to shift the SDI2 signal horizontally in “SIMUL” mode. ON → OFF</p> <p><UNDEF> Undefined</p>
FUNCTION DISPLAY	OFF ON1 <u>ON2</u>	<p>Selects display of functions assigned to [FUNCTION1] - [FUNCTION5] (front panel buttons). It also selects button action (1-touch, 2-touch, off).</p> <p><ON1> 1-touch action to display and perform functions.</p> <p><ON2> 2-touch action to display and perform functions.</p> <p><OFF> No function display.</p>

Main Menu (continued)

FUNCTION setting restrictions

Settings are not available under the following conditions.

Setting	Conditions that disable operation
HV DELAY 2D ONLY	In TWO WINDOW mode, "INVALID FUNCTION" appears to indicate that operation is disabled. When "RGB-COMP." is selected under "YPbPr/RGB" or "DVI-COMP." is selected under "DVI-D" in the "INPUT SELECT" menu, "INVALID FUNCTION" appears to indicate that operation is disabled.
AUTO SETUP 2D ONLY	When something other than "RGB-COMP." is selected under "YPbPr/RGB" in the "INPUT SELECT" menu, "NOT RGB-COMP. CH" appears to indicate that operation is disabled. When "RGB-COMP." is selected under "YPbPr/RGB" in the "INPUT SELECT" menu and no signal is input, "INCOMPLETE" appears to indicate that operation is disabled.
GAMMA SELECT	When GPI is set, "INVALID FUNCTION" appears to indicate that operation is disabled. When "RGB-COMP." is selected under "YPbPr/RGB" or "DVI-COMP." is selected under "DVI-D" in the "INPUT SELECT" menu, "INVALID FUNCTION" appears to indicate that operation is disabled. When "WIDE1" to "WIDE3" is selected under COLOR SPACE, "INVALID FUNCTION" appears to indicate that operation is disabled.
SD ASPECT 2D ONLY	When GPI is set, "INVALID FUNCTION" appears to indicate that operation is disabled. In TWO WINDOW mode and HD signal display, "INVALID FUNCTION" appears to indicate that operation is disabled.
SCAN 2D ONLY	When GPI is set, "INVALID FUNCTION" appears to indicate that operation is disabled. In TWO WINDOW mode, "INVALID FUNCTION" appears to indicate that operation is disabled.
TWO WINDOW 2D ONLY	When "RGB-COMP." is selected under "YPbPr/RGB" or "DVI-COMP." is selected under "DVI-D" in the "INPUT SELECT" menu, the display toggles between single screen display of the main window and sub-window. When WINDOW SIZE is something other than M/M, the SINGLE MAIN and SINGLE SUB screens appear alternately, but no still image screen appears. When the input signal terminals of video displayed in the main window and sub-window differ, the SINGLE MAIN and SINGLE SUB windows appear alternately, but no still image screen appears.
MARKER	When "RGB-COMP." is selected under "YPbPr/RGB" or "DVI-COMP." is selected under "DVI-D" in the "INPUT SELECT" menu, "INVALID FUNCTION" appears to indicate that operation is disabled. When GPI is set during TWO WINDOW operation, "INVALID FUNCTION" appears to indicate that operation is disabled.
LEVEL METER	If input is something other than SDI input or if "INPUT SELECT" of the "AUDIO" menu is set to "ANALOG", "INVALID FUNCTION" appears to indicate that operation is disabled.
MONO	When GPI is set, "INVALID FUNCTION" appears to indicate that operation is disabled.
TIMECODE	When input is something other than HD-SDI input, "INVALID FUNCTION" appears to indicate that operation is disabled.
ANAMO 2D ONLY	When input is something other than HD-SDI signal input, "INVALID FUNCTION" appears to indicate that operation is disabled.
SIMUL MODE 3D ONLY	"INVALID FUNCTION" is displayed to indicate operation is disabled except when 3D mode is set to SIMUL.
H MIRROR 3D ONLY	"INVALID FUNCTION" is displayed to indicate operation is disabled except when 3D mode is set to SIMUL. This function is only available when SIMUL MODE is set to LINE BY LINE or OVERLAY. It is not available when SIMUL MODE is set to SDI1 (L), SDI2 (R), or COMPARISON.

Main Menu (continued)

■ Functions and operating status displayed on screen when FUNCTION buttons are pressed

Pressing any of the [FUNCTION1] to [FUNCTION5] buttons displays the operations assigned to each button as shown below.

- **HV DELAY**
DELAY OFF, H DELAY, V DELAY, HV DELAY
- **AUTOSETUP**
COMP.AUTOSETUP, COMPLETE, INCOMPLETE,
NOT RGB-COMP.CH
- **BLUE ONLY**
BLUE ONLY ON, BLUE ONLY OFF
- **GAMMA SELECT**
GAMMA STANDARD, GAMMA FILM,
GAMMA STDIO/PST
- **COLOR SPACE**
COLOR SPACE SMPTE-C (EX),
COLOR SPACE EBU (EX),
COLOR SPACE SMPTE-C, COLOR SPACE EBU,
COLOR SPACE ITU-709, COLOR SPACE WIDE1,
COLOR SPACE WIDE2, COLOR SPACE WIDE3
- **SD ASPECT**
4:3, 16:9
- **SCAN**
NORMAL SCAN, UNDER SCAN
- **TWO WINDOW**
SINGLE MAIN, TWO L/S, TWO M/M, TWO S/L,
STILL, SINGLE SUB
- **SUB INPUT SEL.**
VIDEO, SDI1, SDI2, YPbPr/RGB, DVI-D
- **MARKER**
MARKER OFF, 4:3 MARKER, 13:9 MARKER,
14:9 MARKER, VISTA MARKER,
CNSCO MARKER, 95% MARKER, 93% MARKER,
90% MARKER, 88% MARKER, 80% MARKER,
xx% MARKER (xx% indicates an 80 to 100%
USER setting),
MARKER ON
16:9 MARKER value / 4:3 MARKER value *1
- **LEVEL METER**
METER OFF, METER 2CH, METER 4CH,
METER 8CH
- **CROSS HATCH**
CROSS HATCH HIGH, CROSS HATCH LOW,
CROSS HATCH OFF
- **MONO**
MONO ON, MONO OFF
- **TIME CODE**
LTC, VITC, LUB, VUB, TC OFF
- **CLOSED CAPTION**
CC1, CC2, CC3, CC4, CC OFF
- **ANAMO**
ANAMO ON, ANAMO OFF
- **3D INPUT TYPE**
SIMUL, LINE BY LINE, SIDE BY SIDE
- **SIMUL MODE**
LINE BY LINE, OVERLAY, SDI1(L), SDI2(R),
COMPARISON
- **H MIRROR**
MIRROR ON, MIRROR OFF

*1 When both 16:9 and 4:3 are set in the marker setting, the 16:9 value is displayed in the first half, and the 4:3 is displayed in the second half.

■ Functions displayed only when in 2D or 3D mode

Certain functions displayed when the FUNCTION button is pressed are only displayed in 2D or 3D mode.

- **Functions not displayed in 3D mode.**
HV DELAY, AUTOSETUP, TWO WINDOW, SD ASPECT, SCAN, SUB INPUT SEL, CLOSED CAPTION, ANAMO
- **Functions not displayed in 2D mode.**
3D INPUT TYPE, SIMUL MODE, H MIRROR

■ “HV DELAY” **2D ONLY**

This displays the blanking period. Each press of the button changes the display as follows: “H blanking display” → “V blanking display” → “H and V blanking display” → “no blanking display.”

Main Menu (continued)

GPI

“GPI CONTROL” is used to enable and disable GPI functions and assign functions to each of the GPI terminal pins (→ page 53).

Underlined values indicate factory defaults.

Sub menu	Settings	Description
GPI CONTROL	<u>DISABLE</u> ENABLE	Enables and disables GPI functions <DISABLE> Disabled <ENABLE> Enabled
GPI1 - GPI8	<u>UNDEF</u> MARKER1 ON/OFF MARKER2 ON/OFF MARKER BACK HALF MARKER BACK BLACK CENTER MARKER INPUT SEL. VIDEO 2D ONLY INPUT SEL. SDI1 INPUT SEL. SDI2 INPUT SEL. YP _B P _R /RGB 2D ONLY INPUT SEL. DVI-D SD ASPECT 2D ONLY SCAN 2D ONLY R-TALLY G-TALLY MONO GAMMA SEL. FILM GAMMA SEL. STDIO/PST SELECT SYNC 2D ONLY	Assigns functions to the GPI control terminal pins. The same items can be set to each terminal (→ page 53).

Note:

This function is not available when,

- “SD ASPECT” operation when input signal is HD or PC
- “SCAN” operation when the input signal is PC
- “GAMMA SELECT” operation when the input signal is PC
- “SELECT SYNC” operation when anything other than “RGB-VIDEO” is selected under “YP_BP_R/RGB” in the “INPUT SELECT” menu
- “MONO” operation when input signal is PC
- “INPUT SEL.SDI1”, “INPUT SEL.SDI2” operations when 3D mode is set to SIMUL

Main Menu (continued)

INPUT SELECT

Underlined values indicate factory defaults.

Sub menu	Settings	Description
VIDEO 2D ONLY	OFF <u>ON</u>	Turns VIDEO line to the INPUT button on/off. *1
FORMAT 2D ONLY	<u>AUTO</u> NTSC PAL	Selects the video input format. *2 <AUTO> Automatically selects NTSC or PAL. <NTSC> NTSC <PAL> PAL
NTSC SETUP 2D ONLY	75 <u>00</u>	Selects NTSC setup level. <75> Select this function when using 7.5% setup signals. (Adjusts the interior of the monitor to the 7.5% setup level to suit the black level) <00> Select this when there is no setup signal.
SDI1 *3	OFF <u>ON</u>	Turns SDI1 line to the INPUT button on/off. *1
SDI2 *3	OFF <u>ON</u>	Turns SDI2 line to the INPUT button on/off. *1
YPbPr/RGB 2D ONLY	OFF <u>ON</u>	Turns YPbPr/RGB line to the INPUT button on/off. *1
MODE 2D ONLY	<u>YPbPr</u> RGB-VIDEO RGB-COMP.	Selects YPbPr (component) or RGB input mode. <YPbPr> Selects the YPbPr signal. <RGB-VIDEO> Selects the video RGB signal. <RGB-COMP.> Selects the PC RGB signal.
COMPONENT LEVEL 2D ONLY	<u>SMPTE</u> B75 B00	Selects YPbPr (component) signal input level. <SMPTE> Signal level complies with SMPTE and P _B and P _R are 0.7 V [p-p] at 100% chroma. <B75> Select this when connecting a Betacam or similar device with a setup function. (Adjusts the interior of the monitor to the 7.5% setup level to suit the black level) <B00> Select this when connecting a Betacam or similar device without a setup function.
SELECT SYNC 2D ONLY	<u>INT</u> EXT	Selects the sync signal when using YPbPr and RGB-VIDEO input. <INT> Select when the synchronizing signal is superimposed on the G or Y signal. <EXT> Select to synchronize with an external synchronizing signal.
COMP. 2D ONLY	▼	Performs analog PC settings. ("COMP." → page 41)
DVI-D *3	OFF <u>ON</u>	Turns DVI-D line to the INPUT button on/off. *1
MODE	<u>DVI-VIDEO</u> DVI-COMP.	Selects DVI-D input mode. <DVI-VIDEO> Selects the RGB signal input of RGB video. <DVI-COMP.> Selects PC input.

*1 All five input lines (VIDEO, SDI1, SDI2, YPbPr/RGB, DVI-D) cannot be turned off. An attempt to turn off all inputs ends when the fourth input line is turned off since it will not be possible to turn off the 5th input line also.

*2 "AUTO" is the factory default, but select a specific format when there is risk that the input signal may be contaminated by outside noise.

*3 When 3D mode is set to SIMUL, the SDI1 and SDI2 lines are selected regardless of the OFF/ON setting.

Main Menu (continued)

COMP. 2D ONLY

Set "RGB-COMP" under "YPbPr/RGB" in the "INPUT SELECT" menu and select the "RGB-COMP." input line to enable the "COMP" menu.

Underlined values indicate factory defaults.

Sub menu	Settings	Description
AUTOSETUP *1 <small>2D ONLY</small>	▼	Automatically adjusts RGB-COMP. as well as H POSITION, V POSITION, PHASE and CLOCK settings of input formats. Selecting this submenu opens a confirmation screen and setup starts after choosing "YES" in this screen.
H POSITION <small>2D ONLY</small>	0 - <u>30</u> - 60	Adjusts horizontal image display position. *2
V POSITION <small>2D ONLY</small>	0 - <u>30</u> - 60	Adjusts vertical image display position. *2
PHASE <small>2D ONLY</small>	0 - <u>16</u> - 60	Adjusts the clock phase in 1/32 clock period increments. *2
CLOCK <small>2D ONLY</small>	700 - 2200 (Factory preset settings: *3)	Adjusts the sampling clock in dot units. *2
WXGA/XGA <small>2D ONLY</small>	<u>XGA</u> WXGA	Switches between XGA (UXGA) and WXGA (WUXGA).
RESET <small>2D ONLY</small>	▼	Returns "H POSITION", "V POSITION", "PHASE" and "CLOCK" settings in the RGB COMP. input compliant format to their factory defaults.

*1 Run "AUTOSETUP" when video is displayed across the entire screen area. If video is distorted, run "AUTOSETUP" after executing "RESET". "EXECUTING" is displayed during "AUTOSETUP" and "COMPLETE" appears when setup completes.

"INCOMPLETE" is displayed if setup could not be completed.

AUTOSETUP may not provide adequate adjustment for some video input. Use H POSITION, V POSITION, PHASE and CLOCK to adjust.

*2 Each input format can be adjusted but not when user data is loaded ("SETUP LOAD" → page 32) or saved ("SETUP SAVE" → page 32).

*3 "CLOCK" factory default

FORMAT	CLOCK	FORMAT	CLOCK
640 × 400 (70 Hz)	800	1024 × 768 (70 Hz)	1328
640 × 480 (60 Hz)	800	1024 × 768 (75 Hz)	1312
640 × 480 (75 Hz)	840	1024 × 768 (85 Hz)	1376
640 × 480 (85 Hz)	832	1280 × 768 (50 Hz)	1648
800 × 600 (60 Hz)	1056	1280 × 768 (60 Hz)	1680
800 × 600 (70 Hz)	1040	1280 × 768 (75 Hz)	1712
800 × 600 (75 Hz)	1056	1280 × 1024 (60 Hz)	1688
800 × 600 (85 Hz)	1048	1600 × 1200 (60 Hz)	2160
1024 × 768 (60 Hz)	1344	1920 × 1200 (60 Hz)	2080

Main Menu (continued)

AUDIO

Use the following submenus to set headphone output and audio level meters.

Underlined values indicate factory defaults.

Sub menu	Settings	Description
INPUT SELECT	<u>AUTO</u> ANALOG	Selects input line for audio output to headphone terminal. However, when 3D mode is set to SIMUL the selection in this menu is applied to the audio signal input from the SDI1 terminal. <AUTO> When an SDI input line is selected with the [INPUT] button on the front panel: Embedded audio (SDI terminal) When input lines other than SDI1 or SDI2 are selected with the [INPUT] button on the front panel: Analog (AUDIO input terminal) <ANALOG> Analog (AUDIO input terminal)
EMBEDDED SELECT L	CH1 - CH8 (Factory default: CH1)	Selects embedded audio channel output to the left (L) headphone.
EMBEDDED SELECT R	CH1 - CH8 (Factory default: CH2)	Selects embedded audio channel output to the right (R) headphone.
LEVEL METER *1	<u>OFF</u> ON	Selects/turns off the audio level meter displayed by OSD.
CH SELECT	<u>8CH</u> 4CH 2CH	Selects the number of audio level meter channels.
0dB POINT	OFF <u>ON</u>	Selects and turns off 0 dB line on/off displayed on the audio level meter.
CH INFO.	OFF <u>ON</u>	Selects and turns off displays on the audio level meter.

*1 When ANALOG is selected in the "INPUT SELECT" menu, the LEVEL METER does not indicate the audio level meter even when set to ON.

Main Menu (continued)

DISPLAY SETUP

Underlined values indicate factory defaults.

Sub menu	Settings	Description
TWO WINDOW SIZE 2D ONLY	L/S <u>M/M</u> S/L	Selects size of split-screen displays. <L/S> main window LARGE, sub-window SMALL <M/M> main window MEDIUM, sub-window MEDIUM <S/L> main window SMALL, sub-window LARGE
SUB INPUT SEL. 2D ONLY	<u>VIDEO</u> SDI1 SDI2 YPbPr/RGB DVI-D	Selects sub-window input in split-screen display.
TIME CODE	<u>OFF</u> ON	Turns the time code display on and off. *1
POSITION	TOP LEFT <u>CENTER</u> RIGHT	Selects position of time code display. <TOP> Top center of screen <LEFT> Bottom left of screen <CENTER> Bottom center of screen <RIGHT> Bottom right of screen
FONT SIZE	<u>LARGE</u> SMALL	Selects font size of time code display. <LARGE> Twice the height and width of menu font size <SMALL> Menu font size
MODE SELECT	<u>LTC</u> VITC LUB VUB	Selects time code display mode. *1 <LTC> Displays linear time code (LTC). <VITC> Displays vertical interval time code (VITC). <LUB> Displays user bits included in LTC. <VUB> Displays user bits included in VITC.
CLOSED CAPTION 2D ONLY	<u>OFF</u> ON	Turns closed caption display on and off. *2
MODE SELECT 2D ONLY	CC4 CC3 CC2 <u>CC1</u>	Selects the closed caption display mode. *2

*1 Available during HD-SDI input signals. Displays the signal input from SDI1 (L) when 3D mode is set to SIMUL.

*2 Available during VIDEO (NTSC) input. Closed captions appear as bright lines on line 21 when closed caption is set to ON and underscan is also on.

Main Menu (continued)

■ TWO WINDOW function 2D ONLY

The "TWO WINDOW" function displays two inputs selected from VIDEO, SDI1/2, YP_BP_R/RGB or DVI-D in two windows.

Each press of the button ([FUNCTION1] to [FUNCTION5]) (→ page 35) to which the "TWO WINDOW" function has been assigned changes the display mode.

Press the FUNCTION button to which the TWO WINDOW function has been assigned.

Main window (normal window)



Video

- Main window: Displays input selected by "INPUT" in a single window.

Press the button again

Main window Sub-window

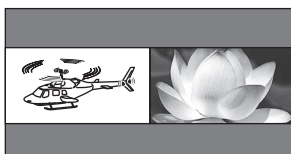

Video

Video

- Main window: Displays input selected by "INPUT."
- Sub-window: Displays input selected in the "SUB INPUT SEL." submenu under the "DISPLAY SETUP" menu. Change "GAMMA SELECT", "COLOR SPACE", "COLOR GAIN R", "COLOR GAIN B" submenu settings in the "VIDEO CONFIG" menu to enable comparison with the main window (video).

Press the button again

Main window Sub-window

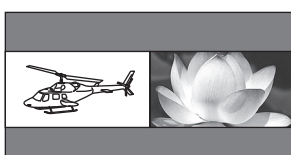

Still image

Video

- Main window: Displays input selected by "INPUT" as a still life image.
- Sub-window: Displays input selected in the "SUB INPUT SEL." submenu under the "DISPLAY SETUP" menu. Change "GAMMA SELECT", "COLOR SPACE", "COLOR GAIN R", "COLOR GAIN B" submenu settings in the "VIDEO CONFIG" menu to enable comparison with the main window (still image).

Press the button again

Sub-window



Video

- Sub-window: Displays input selected in the "SUB INPUT SEL." submenu under the "DISPLAY SETUP" menu in a single window.

Press the button again

Note:

- When the main window and sub-window input setting is "YP_BP_R/RGB" and "RGB-COMP," the main window and sub-window are displayed in a single window. When the input settings for the main window and sub-window are both "DVI-COMP," they are also displayed in a single window.
- When the input signals selected in the main and sub-window differ, the color shade, etc. may differ slightly.
- When the input signal terminals of video displayed in the main window and sub-window differ, the still image function does not work.
- The main window is normally displayed on the left side.
- When SDI1 or SDI2 is selected for the main window and sub-window, both windows will show the same screen.
- When SDI2 and another input (except for a combination of SDI1 and SDI2) are used for the split screen display, TIME CODE and audio level meter display will not function. In this case, use SDI1.

Main Menu (continued)

■ TWO WINDOW size

The "TWO WINDOW SIZE" setting in the "DISPLAY SETUP" menu determines the size of the main window and sub-window.

- Main window (SD) and sub-window (SD)

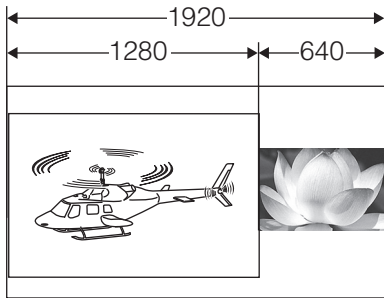

"TWO WINDOW SIZE" setting: L/S
Display size: 4:3 or 5:4

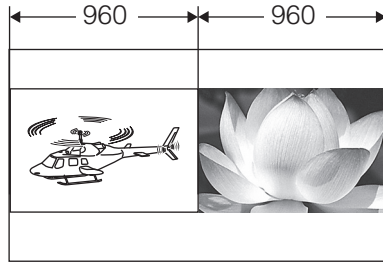

"TWO WINDOW SIZE" setting: M/M

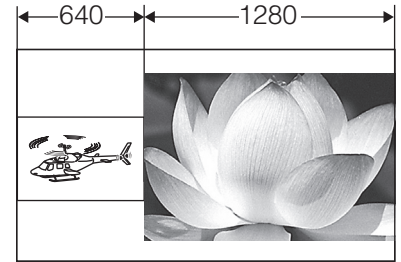

"TWO WINDOW SIZE" setting: S/L

- Main window (HD) and sub-window (HD)

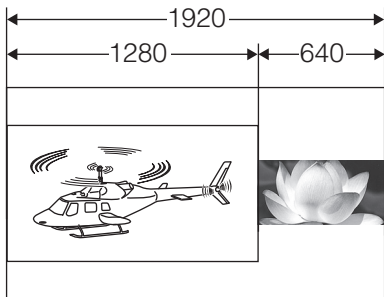

"TWO WINDOW SIZE" setting: L/S
Display size: 16:9 or 16:10

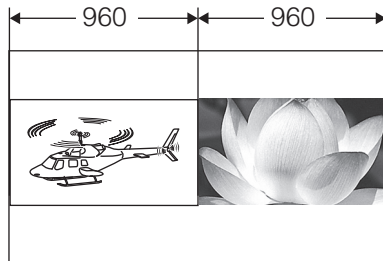

"TWO WINDOW SIZE" setting: M/M

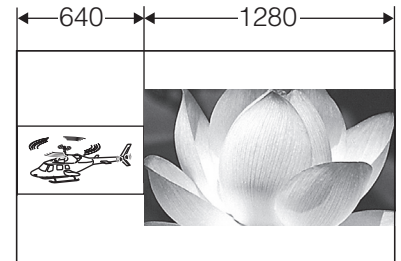

"TWO WINDOW SIZE" setting: S/L

Main Menu (continued)

- Main window (HD) and sub-window (SD)

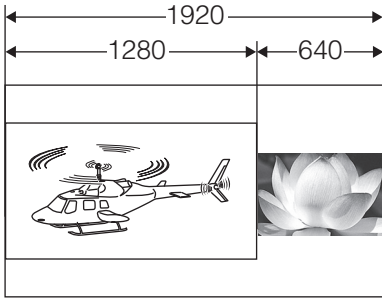

“TWO WINDOW SIZE” setting: L/S
 Display size of main window: 16:9 or 16:10
 Display size of sub-window: 4:3 or 5:4

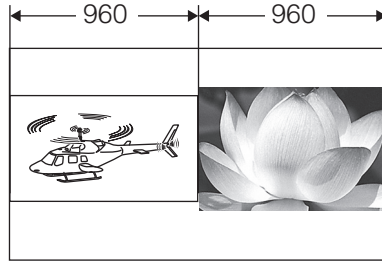

“TWO WINDOW SIZE” setting: M/M

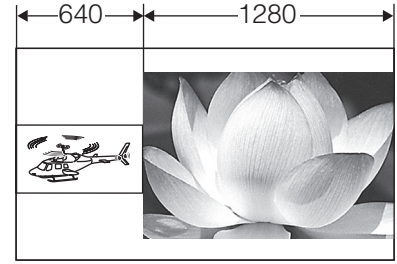

“TWO WINDOW SIZE” setting: S/L

- Main window (SD) and sub-window (HD)

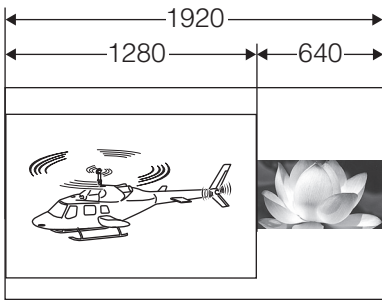

“TWO WINDOW SIZE” setting: L/S
 Display size of main window: 4:3 or 5:4
 Display size of sub-window: 16:9 or 16:10

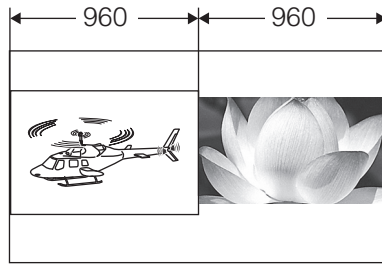

“TWO WINDOW SIZE” setting: M/M

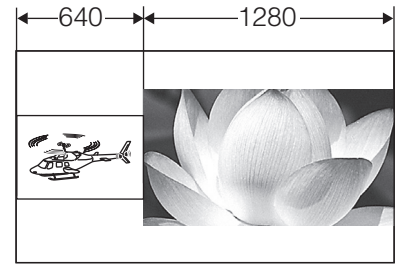

“TWO WINDOW SIZE” setting: S/L

• When the main window and sub-window display video from the same input line, TWO WINDOW SIZE is M/M.

Main Menu (continued)

■ TWO WINDOW screen sync

In single screen display, the TWO WINDOW screen is synchronized to the frame rate frequency of the input signal format.

In split screen display, the screen used as a reference for synchronization changes with the input signal format and "TWO WINDOW SIZE" settings as shown in the following table.

Screen synchronization and display in split-screen mode

TWO WINDOW SIZE	Sub-window Input signal format	1035i 1080i 1080/24PsF	1080p 720p	NTSC PAL 480i/p 576i/p DVI-COMP.	No input or incompatible format
	Main window Input signal format				
L/S	1035i 1080i 1080/24PsF	Main window sync Split-screen display			Main window sync Single screen display
	1080p 720p				
	NTSC PAL 480i/p 576i/p DVI-COMP.				
	No input or incompatible format	Not displayed.			
M/M	1035i 1080i 1080/24PsF	Main window sync Split-screen display	Sub-window sync Split-screen display		Main window sync Single screen display
	1080p 720p				
	NTSC PAL 480i/p 576i/p DVI-COMP.				
	No input or incompatible format	Sub-window sync Single screen display		Not displayed.	
S/L	1035i 1080i 1080/24PsF	Sub-window sync Split-screen display			Not displayed.
	1080p 720p				
	NTSC PAL 480i/p 576i/p DVI-COMP.				
	No input or incompatible format	Sub-window sync Single screen display			

- No screen is displayed when the screen is not synchronized to the reference sync or the reference sync is not input or is in an incompatible format.
- When the frame frequency of the input signal formats of the main window and sub-window differ, frames may be skipped in the screen that is not synchronized to the reference sync.

Main Menu (continued)

CONTROL

Underlined values indicate factory defaults.

Sub menu	Settings	Description
CONTROL	<u>LOCAL</u> REMOTE	Selects operation. (with control clock) <LOCAL> Enables front panel operation <REMOTE> Enables remote operation (front panel operation is locked) *1
LOCAL ENABLE	<u>DISABLE</u> INPUT	Selects the disabled operation on the front panel when selecting "REMOTE" under "CONTROL". Only available when "REMOTE" is selected under "CONTROL". <DISABLE> Disables all front panel operations. <INPUT> Operation using button other than the [INPUT] button is invalid.

*1 The menu can be displayed when the lock is engaged.

Only "CONTROL/LOCAL ENABLE" menu items are available when the lock is engaged.

The picture/volume adjusting menu does not accept changes when the lock is engaged.

The "LOCAL ENABLE" setting determines operations in lock mode.

The key mark is displayed in menu screen and status screen during lock engagement.

Menu Screen



2D Status Screen

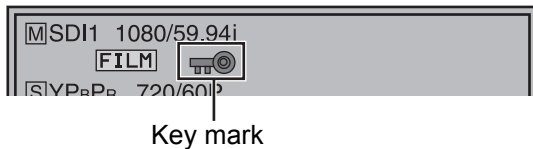

3D Status Screen

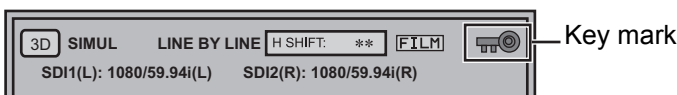

HOURMETER

Sub menu	Settings	Description
OPERATION	XXXXXXh	Displays the number of hours it has been on. 300,000 hours or greater is displayed as "OVER".
LCD	XXXXXXh	Displays the number of hours that the backlight has been on. 300,000 hours or greater is displayed as "OVER".

Main Menu (continued)

■ Setting limitations in 2D mode (○: available, △: can be set, but function is disabled, -: not available)

Setting item	Input CH	VIDEO	SDI 1/2		YPbPr		RGB-VIDEO		RGB-COMP.	DVI-VIDEO		DVI-COMP.
			SD	HD	SD	HD	SD	HD		SD	HD	
3D	SYSTEM	○	○	○	○	○	○	○	○	○	○	○
	3D INPUT TYPE	-	-	-	-	-	-	-	-	-	-	-
	SIMUL MODE	-	-	-	-	-	-	-	-	-	-	-
	H MIRROR	-	-	-	-	-	-	-	-	-	-	-
	H SHIFT	-	-	-	-	-	-	-	-	-	-	-
MARKER	MARKER *1	○	○	○	○	○	○	○	△	○	○	△
	16:9 *1	○	○	○	○	○	○	○	△	○	○	△
	4:3 *1	○	○	○	○	○	○	○	△	○	○	△
	BACK *1	○	○	○	○	○	○	○	△	○	○	△
	CENTER *1	○	○	○	○	○	○	○	△	○	○	△
	GPI PRESET1 *1	○	○	○	○	○	○	○	△	○	○	△
	GPI PRESET2 *1	○	○	○	○	○	○	○	△	○	○	△
	MARKER TYPE *1	○	○	○	○	○	○	○	△	○	○	△
VIDEO CONFIG	CROSS HATCH	○	○	○	○	○	○	○	○	○	○	○
	GAMMA SELECT *2	○	○	○	○	○	○	○	-	○	○	-
	COLOR SPACE *2	○	○	○	○	○	○	○	○	○	○	○
	COLOR TEMP. *3	○	○	○	○	○	○	○	○	○	○	○
	SHARPNESS MODE *3	○	○	○	○	○	○	○	-	○	○	-
	SHARPNESS H *3	○	○	○	○	○	○	○	-	○	○	-
	SHARPNESS V *3	○	○	○	○	○	○	○	-	○	○	-
	I-P MODE *3	○	○	○	○	○	○	○	-	△	○	-
	MONO *3	○	○	○	○	○	○	○	-	○	○	-
	ANAMO *1	△	△	○	△	△	△	△	-	△	△	-
	SD ASPECT *1	○	○	△	○	△	○	△	-	○	△	-
	SCAN *1	○	○	○	○	○	○	○	-	○	○	-
INPUT SELECT	COLOR GAIN R *2	○	○	○	○	○	○	○	-	○	○	○
	COLOR GAIN B *2	○	○	○	○	○	○	○	-	○	○	○
	VIDEO	○	△	△	△	△	△	△	△	△	△	△
	FORMAT	○	△	△	△	△	△	△	△	△	△	△
	NTSC SETUP	○	△	△	△	△	△	△	△	△	△	△
	SDI 1	△	○	○	△	△	△	△	△	△	△	△
	SDI 2	△	○	○	△	△	△	△	△	△	△	△
	YPbPr/RGB	△	-	-	-	-	○	○	○	△	△	△
	MODE	△	△	△	○	○	○	○	○	△	△	△
	COMPONENT LEVEL	△	△	△	○	△	○	△	△	△	△	△
	SELECT SYNC	△	△	△	○	○	○	○	△	△	△	△
	COMP.	-	-	-	-	-	-	-	○	-	-	-
DVI-D	△	△	△	△	△	△	△	△	○	○	○	
MODE	△	△	△	△	△	△	△	△	○	○	○	

*1 This function is not available in the split-screen display of the "TWO WINDOW" function.

*2 Settings are reflected to the sub-window in the split-screen display of the "TWO WINDOW" function.

*3 Settings are reflected to the main window and the sub-window in the split-screen display of the "TWO WINDOW" function.

Main Menu (continued)

Setting item		Input CH VIDEO	SDI 1/2		YP _b P _R		RGB-VIDEO		RGB-COMP.	DVI-VIDEO		DVI-COMP.
			SD	HD	SD	HD	SD	HD		SD	HD	
AUDIO	INPUT SELECT	○	○	○	○	○	○	○	○	○	○	○
	EMBEDED SELECT L	○	○	○	○	○	○	○	○	○	○	○
	EMBEDED SELECT R	○	○	○	○	○	○	○	○	○	○	○
	LEVEL METER	△	○	○	△	△	△	△	△	△	△	△
	CH SELECT	△	○	○	△	△	△	△	△	△	△	△
	0dB POINT	△	○	○	△	△	△	△	△	△	△	△
	CH INFO.	△	○	○	△	△	△	△	△	△	△	△
DISPLAY SETUP	TWO WINDOW SIZE	○	○	○	○	○	○	○	-	○	○	○
	SUB INPUT SEL.	○	○	○	○	○	○	○	-	○	○	○
	TIME CODE	△	△	○	△	△	△	△	△	△	△	△
	POSITION	△	△	○	△	△	△	△	△	△	△	△
	FONT SIZE	△	△	○	△	△	△	△	△	△	△	△
	MODE SELECT	△	△	○	△	△	△	△	△	△	△	△
	CLOSED CAPTION	○	△	△	△	△	△	△	△	△	△	△
Picture adjustment	MODE SELECT	○	△	△	△	△	△	△	△	△	△	△
	PHASE	○	○	○	○	○	○	○	-	○	○	-
	CHROMA	○	○	○	○	○	○	○	-	○	○	-
	BRIGHT	○	○	○	○	○	○	○	○	○	○	○
	CONTRAST	○	○	○	○	○	○	○	○	○	○	○
BACKLIGHT	○	○	○	○	○	○	○	○	○	○	○	

Main Menu (continued)

■ Setting limitations in 3D mode (○: available, △: can be set, but function is disabled, -: not available)

Setting item	Input CH	SDI 1/2	DVI-VIDEO	DVI-COMP.
		HD	HD	
3D	SYSTEM	○	○	○
	3D INPUT TYPE	○	○	○
	SIMUL MODE *1	○	○	○
	H MIRROR *1	○	○	○
	H SHIFT *1	○	○	○
MARKER	MARKER	○	○	△
	16:9	○	○	△
	4:3	○	○	△
	BACK	○	○	△
	CENTER	○	○	△
	GPI PRESET1	○	○	△
	GPI PRESET2	○	○	△
	MARKER TYPE	○	○	△
VIDEO CONFIG	CROSS HATCH	○	○	○
	GAMMA SELECT	○	○	-
	COLOR SPACE	○	○	○
	COLOR TEMP.	○	○	○
	SHARPNESS MODE	○	○	-
	SHARPNESS H	○	○	-
	SHARPNESS V	-	-	-
	I-P MODE	-	-	-
	MONO	○	○	-
	ANAMO	-	-	-
	SD ASPECT	-	-	-
	SCAN	-	-	-
	COLOR GAIN R	○	○	○
COLOR GAIN B	○	○	○	
INPUT SELECT	VIDEO	-	-	-
	FORMAT	-	-	-
	NTSC SETUP	-	-	-
	SDI 1	○	△	△
	SDI 2	○	△	△
	YP _B Pr/RGB	-	-	-
	MODE	-	-	-
	COMPONENT LEVEL	-	-	-
	SELECT SYNC	-	-	-
	COMP.	-	-	-
	DVI-D	△	○	○
	MODE	△	○	○
AUDIO	INPUT SELECT	○	○	○
	EMBEDED SELECT L	○	○	○
	EMBEDED SELECT R	○	○	○
	LEVEL METER	○	△	△
	CH SELECT	○	△	△
	0dB POINT	○	△	△
	CH INFO.	○	△	△

*1 This function can only be set when SIMUL is selected for the "3D INPUT TYPE" option.

Main Menu (continued)

Setting item		Input CH	SDI 1/2	DVI-VIDEO	DVI-COMP.
		HD	HD	HD	
DISPLAY SETUP	TWO WINDOW SIZE	-	-	-	-
	SUB INPUT SEL.	-	-	-	-
	TIME CODE	○	△	△	△
	POSITION	○	△	△	△
	FONT SIZE	○	△	△	△
	MODE SELECT	○	△	△	△
	CLOSED CAPTION	-	-	-	-
	MODE SELECT	-	-	-	-
Picture adjustment	PHASE	○	○	○	-
	CHROMA	○	○	○	-
	BRIGHT	○	○	○	○
	CONTRAST	○	○	○	○
	BACKLIGHT	○	○	○	○

REMOTE Specifications

This monitor permits remote operation via GPI/RS-232C terminal.

GPI terminal

GPI screen items correspond to the following terminals. Use the GPI menu to assign functions to each terminal (→ page 39). Functions assigned to terminals are executed when GND (pin 5) is short-circuited (ON) or open (OFF).

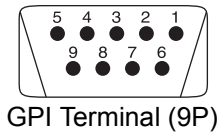

Pin number	Signal
1	GPI1
2	GPI2
3	GPI3
4	GPI4
5	GND
6	GPI5
7	GPI6
8	GPI7
9	GPI8

Operating conditions

Level operation: Operates when GND is short-circuited.

Edge operation: Operates when GND changes from open to short-circuited.

- When level operation is assigned to more than one terminal, the function operates as long as one of the terminals is short-circuited.

Edge operation should hold for 0.2 s or more after a change.

Assigned item	Function	Operating conditions
UNDEF	Undefined (no function assigned)	—
MARKER1 ON/OFF *1	Switches marker display defined in “GPI PRESET1” (→ page 26) in the “MARKER” menu.	Level operation (Short-circuited: ON, Open: OFF)
MARKER2 ON/OFF *1	Switches marker display defined in “GPI PRESET2” (→ page 26) in the “MARKER” menu.	Level operation (Short-circuited: ON, Open: OFF)
MARKER BACK HALF *2	Reduces the brightness of the background outside the marker displayed in “GPI PRESET1” (→ page 26) to 50%.	Level operation (Short-circuited: ON, Open: OFF)
MARKER BACK BLACK *2	Reduces the brightness of the background outside the marker displayed in “GPI PRESET1” (→ page 26) to 0%.	Level operation (Short-circuited: ON, Open: OFF)
CENTER MARKER	Turns the center marker display on and off. (When other markers are displayed, this marker is superimposed on other markers.)	Level operation (Short-circuited: ON, Open: OFF)
INPUT SEL. VIDEO 2D ONLY	Switches the input line of the main window to VIDEO.	Edge/level operation
INPUT SEL. SDI1	Switches the input line of the main window to SDI1.	Edge/level operation
INPUT SEL. SDI2	Switches the input line of the main window to SDI2.	Edge/level operation
INPUT SEL. YPBPr/RGB 2D ONLY	Switches the input line of the main window to YPBPr/RGB.	Edge/level operation
INPUT SEL. DVI-D	Switches the input line of the main window to DVI-D.	Edge/level operation
SD ASPECT 2D ONLY	Sets the aspect ratio for SD signal input in the main window or sub-window single screen display.	Level operation (Short-circuited: 16:9, open: 4:3)
SCAN 2D ONLY	Switches between “UNDER” and “NORMAL” scan modes in the main window or sub-window single screen display.	Level operation (Short-circuited: UNDER, Open: NORMAL)
R-TALLY *3	Lights the red tally.	Level operation (Short-circuited: ON, Open: OFF)
G-TALLY *3	Lights the green tally.	Level operation (Short-circuited: ON, Open: OFF)
MONO	Switches between color and monochrome (MONO). (Disabled during PC signal input)	Level operation (Short-circuited: monochrome, Open: color)
GAMMA SEL. FILM	Switches the gamma curve in the main window to FILM mode.	Level operation (Short-circuited: FILM mode, Open: STANDARD mode)
GAMMA SEL. STUDIO/PST	Switches the gamma curve in the main window to STUDIO/PST mode.	Level operation (Short-circuited: STUDIO/PST mode, Open: STANDARD mode)
SELECT SYNC 2D ONLY	Selects the SYNC when using YPBPr and RGB-VIDEO input.	Level operation (Short-circuited: EXT, Open: INT)

*1 When a 16:9 marker and a 4:3 marker are simultaneously selected and activated on a 16:9 aspect ratio display, both markers are displayed.

*2 When a 16:9 marker and a 4:3 marker are simultaneously displayed, the background of the marker selected by the 16:9 marker is controlled.

*3 When “R-TALLY” and “G-TALLY” simultaneously go on, the tally color changes to orange.

REMOTE Specifications (continued)

Priority of assigned functions

- When both “MARKER1” and “MARKER2” are activated at the same time, “MARKER1” has priority. However, when the display aspect ratio is 4:3, the “MARKER1” aspect ratio is 16:9 and the “MARKER2” aspect ratio is 4:3, “MARKER2” is displayed. In this case, the “MARKER2” background is controlled.
- When “MARKER BACK HALF” and “MARKER BACK BLACK” are activated at the same time, “MARKER BACK BLACK” has priority.
- During GPI edge operation and two or more of “INPUT SEL. VIDEO”, “INPUT SEL. SDI1”, “INPUT SEL. SDI2”, “INPUT SEL. YPbPr/RGB” and “INPUT SEL. DVI-D” are simultaneously activated, priority goes to the last activated item. During level operation, priority is assigned in the following order: “INPUT SEL. VIDEO”, “INPUT SEL. SDI1”, “INPUT SEL. SDI2”, “INPUT SEL. YPbPr/RGB” and “INPUT SEL. DVI-D”.
- When “GAMMA SEL. FILM” and “GAMMA SEL. STUDIO/PST” are activated at the same time, “GAMMA SEL. FILM” has priority.

RS-232C terminal

The following diagram and the table on the lower right show RS-232C terminal pin arrangement and connections. For details on systems using RS-232C, be sure to consult your dealer.

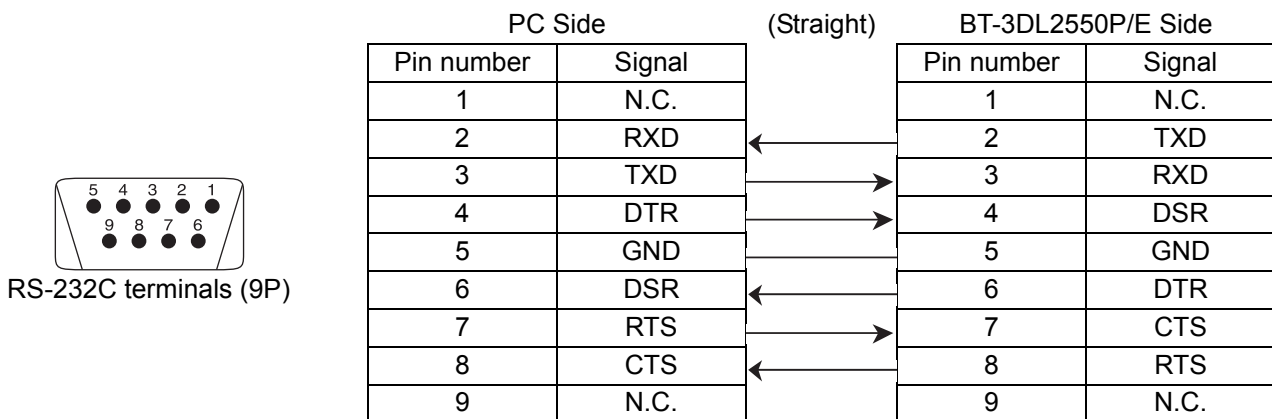

RS-232C remote control method

Connectors and signals

Connector: D-SUB 9-pin (female)
Signal

Pin number	Signal	Description
1	N.C.	Not connected
2	TXD	Transmission data
3	RXD	Reception data
4	DSR	Connected inside
5	GND	Ground
6	DTR	Connected inside
7	CTS	Connected inside
8	RTS	Connected inside
9	N.C.	Not connected

Communication parameters

Signal level	RS-232C compliant
Synchro system	Asynchronous
Transfer rate	9600 bps
Parity	None
Data length	8 bit
Stop bit	1 bit
Flow control	None

Command format

STX (02h)	Command	:	Data	ETX (03h)
-----------	---------	---	------	-----------

- The command is the 3-character string starting with STX and ending with ETX.
- Append any data after the colon (:) following the command, as required.

Response formats

1. Setting command response

STX (02h)	Command	ETX (03h)
-----------	---------	-----------

2. Query command response

STX (02h)	Data	ETX (03h)
-----------	------	-----------

3. Error response

STX (02h)	Error code	ETX (03h)
-----------	------------	-----------

Error codes

ER001: Invalid command

ER002: Parameter error

REMOTE Specifications (continued)

Setting command

No	Command	Description	Data	Response
1	IIS ^{*1}	Input switch	0: SDI1 1: SDI2 2: VIDEO 2D ONLY 3: YP _B Pr/RGB 2D ONLY 6: DVI-D	IIS
2	VPC ^{*2}	Image quality adjustment	CON00-60 : Contrast settings BRI00-60 : Brightness settings CRO00-60 : Chroma settings PHA00-60 : Phase settings	VPC
3	OBO ^{*2}	Blue only	0: OFF 1: ON	OBO
4	OHV ^{*1} 2D ONLY	HV Delay	0: OFF 1: H DELAY 2: V DELAY 3: HV DELAY	OHV
5	VBL ^{*2}	Backlight	00-60: Backlight setting	VBL
6	DCH ^{*2}	Cross hatch	0: OFF 1: LOW 2: HIGH	DCH
7	DSD ^{*2}	Status display	0: CONTINUE 1: 3SEC OFF 2: OFF	DSD
8	ISM ^{*2} 2D ONLY	Analog mode	ANA0: YP _B Pr ANA1: RGB-VIDEO ANA2: RGB-COMP.	ISM
9	IRF ^{*2} 2D ONLY	SELECT Sync	0: INT 1: EXT	IRF
10	ISM ^{*2}	DVI-D mode	DVI0: DVI-VIDEO DVI1: DVI-COMP.	ISM
11	DMK ^{*3}	Marker settings	16:9 marker MK100: OFF MK101: 80% MK102: 88% MK103: 93% MK104: 95% MK105: 14:9 MK106: 13:9 MK107: 4:3 MK108: 90% MK109: CNSCO MK110: VISTA MK1xxx: USER (range: 080 - 100%) 4:3 marker MK200: OFF MK201: 80% MK202: 88% MK203: 93% MK204: 95% MK208: 90% MK2xxx: USER (range: 080 - 100%) Marker background BAK0: NORMAL BAK1: HALF BAK2: BLACK Center marker CMK0: OFF CMK1: ON	DMK
12	MGM ^{*1}	Gamma selection	1: STANDARD 2: FILM 3: STUDIO/PST	MGM
13	MCT ^{*2}	Color temperature settings	00: D56 01: D65 02: D93 03: VAR1 04: VAR2 05: VAR3 10-73: USER0 - 63	MCT
14	VPC ^{*2}	Sharpness settings	SHP0: LOW SHP1: HIGH SHH00-30: Horizontal sharpness settings SHV00-30: Vertical sharpness settings 2D ONLY	VPC
15	MIP ^{*1} 2D ONLY	IP mode settings	0: MODE1 1: MODE2	MIP

*1 This command is enabled in single screen display in "TWO WINDOW" mode and in the main window in split-screen display.

*2 This command is enabled in single screen display in "TWO WINDOW" mode and in the main window and sub-window in split-screen display.

*3 This command is enabled in the sub-window in single screen display in "TWO WINDOW" mode.

REMOTE Specifications (continued)

No	Command	Description	Data		Response
16	OMO * ²	Monochrome settings	1: OFF	2: ON	OMO
17	MAS * ³ 2D ONLY	SD aspect settings	0: 16:9	1: 4:3	MAS
18	MSC * ³ 2D ONLY	Scan settings	0: NORMAL	1: UNDER	MSC
19	MCO * ²	Remote settings	0: LOCAL	1: REMOTE	MCO
20	MLE * ²	Remote operation settings	0: DISABLE	1: INPUT	MLE
21	DIT	3D input type settings	0: SIMUL 2: SIDE BY SIDE	1: LINE BY LINE	DIT
22	DSM	SIMUL settings	0: LINE BY LINE 2: SDI1 (L) 4: COMPARISON	1: OVERLAY 3: SDI2 (R)	DSM
23	DHM	Mirror settings	0: OFF	1: ON	DHM

*² This command is enabled in single screen display in "TWO WINDOW" mode and in the main window and sub-window in split-screen display.

*³ This command is enabled in the sub-window in single screen display in "TWO WINDOW" mode.

■ Query command

This command returns the main window setting.

No	Command	Description	Data	Response
1	QIS * ¹	Input selection		0: SDI1 2: YPbPr 2D ONLY 4: VIDEO 2D ONLY 9: DVI-VIDEO 1: SDI2 3: RGB-VIDEO 2D ONLY 6: RGB-COMP. 2D ONLY 10: DVI-COMP.
2	QPC	Image quality adjustment	CON : Contrast setting value BRI : Brightness setting value CRO : Chroma setting value PHA : Phase setting value	00-60 00-60 00-60 00-60
3	QBO	Blue only		0: OFF 1: ON
4	QBL	Backlight		00-60
5	QCH	Cross hatch		0: OFF 1: LOW 2: HIGH
6	QMK	Marker	MAK : Area marker * ² BAK : Background CMK : Center marker	00: OFF 03: 93% 06: 13:9 09: CNSCO 80-100: USER80 - 100 01: 80% 04: 95% 07: 4:3 10: VISTA 02: 88% 05: 14:9 08: 90% 0: NORMAL 1: HALF 2: BLACK 0: OFF 1: ON
7	QGM	Gamma		1: STANDARD 2: FILM 3: STDIO/PST
8	QCT	Color temperature		00: D56 03: VAR1 10-73: USER0 - 63 01: D65 04: VAR2 02: D93 05: VAR3
9	QPC	Sharpness	SHP : Sharpness mode SHH : Horizontal sharpness value SHV : Vertical sharpness value 2D ONLY	0: LOW 1: HIGH 00-30 00-30
10	QIP 2D ONLY	IP mode		0: MODE1 1: MODE2
11	QMO	Monochrome		1: OFF 2: ON

*¹ When in SIMUL mode, only "0:SDI1" responds.

*² Returns the 16:9 marker status when both 16:9 and 4:3 markers are displayed.

REMOTE Specifications (continued)

No	Command	Description	Data	Response
12	QAS 2D ONLY	Aspect		0: 16:9 1: 4:3
13	QSC 2D ONLY	Scan		0: NORMAL 1: UNDER
14	QAN 2D ONLY	Analog mode		0: YPbPr 1: RGB-VIDEO 2: RGB-COMP.
15	QSY 2D ONLY	SELECT sync		0: INT 1: EXT
16	QDV	DVI-D mode		0: DVI-VIDEO 1: DVI-COMP.
17	QFR	Format		00: NO SIGNAL 01: 1080/60i 02: 1080/59i 03: 1080/50i 04: 1080/30p 2D ONLY 05: 1080/29p 2D ONLY 06: 1080/25p 2D ONLY 07: 1080/24p 2D ONLY 08: 1080/23p 2D ONLY 09: 1080/24PsF 10: 1080/23PsF 13: 720/60p 14: 720/59p 15: 576/50i 2D ONLY 16: 480/60p 2D ONLY 17: 480/60i 2D ONLY 18: 576/50p 2D ONLY 20: 1080/60p 2D ONLY 21: 1080/59p 2D ONLY 22: 1080/50p 2D ONLY 23: 720/50p 50: 640 × 400 (70 Hz) 2D ONLY 51: 640 × 480 (60 Hz) 2D ONLY 52: 640 × 480 (75 Hz) 2D ONLY 53: 640 × 480 (85 Hz) 2D ONLY 54: 800 × 600 (60 Hz) 2D ONLY 55: 800 × 600 (75 Hz) 2D ONLY 56: 800 × 600 (85 Hz) 2D ONLY 57: 1024 × 768 (60 Hz) 2D ONLY 58: 1024 × 768 (70 Hz) 2D ONLY 59: 1024 × 768 (75 Hz) 2D ONLY 60: 1024 × 768 (85 Hz) 2D ONLY 61: 1280 × 768 (60 Hz) 2D ONLY 62: 1280 × 768 (75 Hz) 2D ONLY 63: 1280 × 1024 (60 Hz) 2D ONLY 64: 800 × 600 (70 Hz) 2D ONLY 65: 1280 × 768 (50 Hz) 2D ONLY 66: 1600 × 1200(60 Hz) 2D ONLY 67: 1920 × 1200(60 Hz) FF: UNSUPPORT SIGNAL
18	QID	Model		BT-3DL2550
19	QIT	3D input type settings		0: SIMUL 2: SIDE BY SIDE 1: LINE BY LINE
20	QSM	SIMUL settings		0: LINE BY LINE 2: SDI1 (L) 4: COMPARISON 1: OVERLAY 3: SDI2 (R)
21	QHM	Mirror settings		0: OFF 1: ON

Maintenance inspections

Maintenance inspections through periodic and appropriate maintenance are essential to keep the monitor in optimum condition and ensure safe operation. Be sure to conduct the following maintenance inspections to enable long-term, full use of all its functions.

Necessity of periodic maintenance service

The backlight in the LCD panel is a consumable component that deteriorates over time leading to gradual loss of performance that could eventually result in a malfunction.

Conventional after-sales service that replaces parts when they break down should therefore be combined with a regularly conducted comprehensive service to maintain normal operation and prevent unforeseen breakdown of consumables.

Care and cleaning of the monitor

- Clean the cabinet and protection panel by gently wiping it with a soft cloth.
To remove stubborn soiling, use a cloth dampened in a weak neutral detergent solution and thoroughly wrung out. Then wipe with a dry cloth. Any moisture entering the monitor could damage it.
- Do not use benzene, thinner and similar solvents for cleaning.
They could discolor the surface and cause the paint to peel.
- Do not directly expose the monitor to spray cleaning.
Any moisture entering the monitor could damage it.

Care and storage of 3D Polarized Eyewear

- Use a soft dry cloth intended for use on eye-glasses when cleaning this product. Remove lint from the cloth before use as it may damage the product. Do not use benzene, thinner or similar solvents for cleaning as they could discolor the surface and cause the paint to peel.
- Do not apply water or other liquids to the 3D Polarized Eyewear when cleaning.
- Avoid storing 3D Polarized Eyewear in places with a high temperature or high humidity.
- Contact your dealer if additional 3D Polarized Eyewear is required.

Error Display

When an error has occurred for some reason, the tally lamp notifies the error.

Error display	Symptom	Remedy
Inverter error The tally lamp flashes red at 1-second intervals.	If a malfunction occurs in the inverter that controls backlight brightness, the backlight goes off and the screen turns black.	Turn off the power and then turn it back on. If the problem still persists, consult your dealer.

Before calling for support

When a fault is suspected (Troubleshooting)

If unresolved issues remain after referring to the points below, please consult the store from which the product was purchased.

Symptom	Remedy
Image is not 3D	<ul style="list-style-type: none">• Is the monitor switched to 3D image mode? Even in 3D mode, there is a non-stereoscopic mode.• Persons with a large difference in visual acuity between their left and right eyes may have difficulty seeing 3D images, or may not be able to see them at all. Use this monitor after taking the appropriate vision correction measures.
The 3D video looks strange	<ul style="list-style-type: none">• Is the 3D image horizontally inverted? Ensure that the left eye image signal and the right eye image signal are input correctly when in SIMUL mode.

Specifications

General

Supply Voltage 24 V DC, 4.5 A 5 V DC, 0.03 A

 indicates safety information.

Dimensions (W × H × D):

599 mm × 440 mm × 220 mm
(23-5/8 inches × 17-5/16 inches ×
8-11/16 inches) (Including stand)
599 mm × 410 mm × 100 mm
(23-5/8 inches × 16-1/8 inches ×
3-15/16 inches) (Not including stand)

Mass: approx. 10.3 kg (22.7 lb)
(Including stand)
approx. 8.8 kg (19.4 lb)
(Not including stand)

Ambient temperature: 5 °C to 35 °C (41 °F to 95 °F)

Operating humidity: 20% to 80% (no condensation)

Storage temperature: -20 °C to 60 °C (-4 °F to 140 °F)

Display panel

Size: 25.5 type
Aspect ratio: 16:10
Number of pixels: 1920 × 1200 (WUXGA)
Display colors: approx. 16.77 million colors
View angle: 178° both vertically and horizontally
Panel surface: Xpol® polarizing panel

Connectors

Input

VIDEO input terminal BNC × 1
SDI input terminal BNC × 2
Compliant with SMPTE 274M, 296M, 259M-C
and ITU-R BT.656-4
EMBEDDED AUDIO
YP_BPR/RGB input terminal BNC × 3
SYNC/HD input terminal BNC × 1
SYNC signal level 0.3 V [p-p] - 4.0 V [p-p]
HD signal level TTL level
VD input terminal BNC × 1
VD signal level TTL level
DVI-D input terminal DVI-D × 1
HDCP compatible, TMDS single link
Vertical frequency 50.0 Hz - 60.0 Hz
Horizontal frequency 31.5 kHz - 67.5 kHz
Dot clock 25 MHz - 165 MHz
AUDIO input terminals Pin jack × 2 (stereo)
Signal level 0.5 V_{rms}
DC IN terminals XLR 4 pins × 1

Output:

VIDEO output terminals BNC × 1
Through-out (Automatic
75 Ω termination)
SDI output terminals BNC × 2
Active through output

YP_BPR/RGB output terminals

BNC × 3
Through-out (Automatic
75 Ω termination)

SYNC/HD output terminals

BNC × 1
Through-out (Automatic
1 kΩ termination)

VD output terminals

BNC × 1
Through-out (Automatic
1 kΩ termination)

Headphone output terminals

Stereo mini-jack M3 × 1
32 Ω, adjustable level

REMOTE:

GPI D-SUB 9-pin × 1
RS-232C D-SUB 9-pin × 1

AC adapter

Supply Source	100 V - 240 V, 50/60 Hz 1.6 A - 0.6 A
Power Output	24 V DC, 4.5 A 5 V DC, 0.03 A

 indicates safety information.

Dimensions (W × H × D):

232 mm × 50.5 mm × 177 mm
(9-1/8 inches × 2 inches × 6-15/16
inches)

Mass: approx. 1.7 kg (3.5 lb)

Inrush current, measured according to European
standard EN55103-1: 10.0 A

Specifications (continued)

■ Signal formats supported in 2D mode (○: Compatible, △: Limited compatibility, -: Not compatible)

Input signal formats	VIDEO	SDI1	SDI2	YPbPr	RGB-VIDEO	RGB-COMP.	DVI-VIDEO	DVI-COMP.
NTSC	○	-	-	-	-	-	-	-
PAL	○	-	-	-	-	-	-	-
480/59.94i	-	○	○	○	○	-	-	-
480/59.94p	-	-	-	○	○	-	○	-
576/50i	-	○	○	○	○	-	-	-
576/50p	-	-	-	○	○	-	○	-
720/50p	-	○	○	○	-	-	○	-
720/59.94p	-	○	○	○	○	-	○	-
720/60p	-	○	○	○	○	-	○	-
1035/59.94i	-	△*1	△*1	△*1	△*1	-	-	-
1035/60i	-	△*2	△*2	△*2	△*2	-	-	-
1080/23.98PsF	-	○	○	○	-	-	-	-
1080/24PsF	-	○	○	○	-	-	-	-
1080/23.98p	-	○	○	○	-	-	-	-
1080/24p	-	○	○	○	-	-	-	-
1080/25p	-	○	○	○	-	-	-	-
1080/29.97p	-	○	○	○	-	-	-	-
1080/30p	-	○	○	○	-	-	-	-
1080/50i	-	○	○	○	○	-	○	-
1080/50p	-	-	-	○	-	-	○	-
1080/59.94i	-	○	○	○	○	-	○	-
1080/60i	-	○	○	○	○	-	○	-
1080/59.94p	-	-	-	○	-	-	○	-
1080/60p	-	-	-	○	-	-	○	-
640 × 400 (70 Hz)	-	-	-	-	-	○	-	-
640 × 480 (60 Hz)	-	-	-	-	-	○	-	○
640 × 480 (75 Hz)	-	-	-	-	-	○	-	-
640 × 480 (85 Hz)	-	-	-	-	-	○	-	-
800 × 600 (60 Hz)	-	-	-	-	-	○	-	○
800 × 600 (70 Hz)	-	-	-	-	-	○	-	-
800 × 600 (75 Hz)	-	-	-	-	-	○	-	-
800 × 600 (85 Hz)	-	-	-	-	-	○	-	-
1024 × 768 (60 Hz)	-	-	-	-	-	○	-	○
1024 × 768 (70 Hz)	-	-	-	-	-	○	-	-
1024 × 768 (75 Hz)	-	-	-	-	-	○	-	-
1024 × 768 (85 Hz)	-	-	-	-	-	○	-	-
1280 × 768 (50 Hz)	-	-	-	-	-	○	-	○
1280 × 768 (60 Hz)	-	-	-	-	-	○	-	○
1280 × 768 (75 Hz)	-	-	-	-	-	○	-	-
1280 × 1024 (60 Hz)	-	-	-	-	-	○	-	○
1600 × 1200 (60 Hz)	-	-	-	-	-	○	-	○
1920 × 1200 (60 Hz)	-	-	-	-	-	△*3	-	○

*1 When 1035/59.94i signal is input, displayed as 1080/59.94i. Other various marker displays will use the 1080/59.94i marker.

*2 When 1035/60i signal is input, displayed as 1080/60i. Other various marker displays will use the 1080/60i marker.

*3 Only compatible with VESA (Video Electronics Standards Association) Reduced Blanking (Clock: 154 MHz, Hsync: positive logic, Vsync: negative logic).

Specifications (continued)

■ Signal formats supported in 3D mode (○: Compatible, △: Limited compatibility, -: Not compatible)

Input signal formats	SIMUL	LINE BY LINE			SIDE BY SIDE	
	SDI	SDI	DVI-VIDEO	DVI-COMP	SDI	DVI-VIDEO
720/50p	○ ^{*3}	○ ^{*3}	○ ^{*3}	-	○ ^{*3}	○ ^{*3}
720/59.94p	○ ^{*3}	○ ^{*3}	○ ^{*3}	-	○ ^{*3}	○ ^{*3}
720/60p	○ ^{*3}	○ ^{*3}	○ ^{*3}	-	○ ^{*3}	○ ^{*3}
1035/59.94i	△ ^{*1}	-	-	-	△ ^{*1}	-
1035/60i	△ ^{*2}	-	-	-	△ ^{*2}	-
1080/23.98PsF	○	-	-	-	○	-
1080/24PsF	○	-	-	-	○	-
1080/25PsF	○ ^{*5}	-	-	-	○ ^{*5}	-
1080/29.97PsF	○ ^{*6}	-	-	-	○ ^{*6}	-
1080/30PsF	○ ^{*7}	-	-	-	○ ^{*7}	-
1080/50i	○	-	-	-	○	○
1080/59.94i	○	-	-	-	○	○
1080/60i	○	-	-	-	○	○
1920 × 1200 (60 Hz)	-	-	-	○ ^{*4}	-	-

*1 When 1035/59.94i signal is input, displayed as 1080/59.94i. Other various marker displays will use the 1080/59.94i marker. At this time the top of the screen will flicker. This is not a fault.

*2 When 1035/60i signal is input, displayed as 1080/60i. Other various marker displays will use the 1080/60i marker. At this time the top of the screen will flicker. This is not a fault.

*3 Displayed dot by dot in 3D mode (except COMPARISON) without altering the input signal size.

*4 Only supported with LINE BY LINE format.

*5 Displayed as 1080/50i when input is 1080/25PsF.

*6 Displayed as 1080/59.94i when input is 1080/29.97PsF.

*7 Displayed as 1080/60i when input is 1080/30PsF.

Weight and dimensions when shown are approximately.
Specifications are subject to change without notice.

Information on Disposal for Users of Waste Electrical & Electronic Equipment (private households)



This symbol on the products and/or accompanying documents means that used electrical and electronic products should not be mixed with general household waste.

For proper treatment, recovery and recycling, please take these products to designated collection points, where they will be accepted on a free of charge basis. Alternatively, in some countries you may be able to return your products to your local retailer upon the purchase of an equivalent new product.

Disposing of this product correctly will help to save valuable resources and prevent any potential negative effects on human health and the environment which could otherwise arise from inappropriate waste handling. Please contact your local authority for further details of your nearest designated collection point.

Penalties may be applicable for incorrect disposal of this waste, in accordance with national legislation.

For business users in the European Union

If you wish to discard electrical and electronic equipment, please contact your dealer or supplier for further information.

Information on Disposal in other Countries outside the European Union

This symbol is only valid in the European Union.

If you wish to discard this product, please contact your local authorities or dealer and ask for the correct method of disposal.

Panasonic Corporation

Web Site: <http://panasonic.net>

Panasonic Solutions Company

3 Panasonic Way, Secaucus, NJ 07094 Tel: 877-803-8492

www.panasonic.com/broadcast e-mail: MediaProServices.PSC@us.panasonic.com

Panasonic Canada Inc.

5770 Ambler Drive, Mississauga, Ontario L4W 2T3 Tel: 905-624-5010

Panasonic de México S.A. De C.V.

Casa Matriz: Moras No.313 Col. Tlacoquemecatl Del Valle Del.Benito Juárez México, D.F., C.P.03200

Tel: 55-5488-1000 Fax: 55-5575-6783

Panasonic Latin America, S.A.

P.O.Box 0816-03164 Panama, Republic of Panama Tel: +507-229-2955 Fax: 507-229-5352

Panasonic do Brasil Ltda.

Rua Cubatão, 320-6º andar-Paraíso CEP 04013-001- São Paulo -SP Tel: 11-3889-4000 Fax: 11-3889-4004