

ASSEMBLY

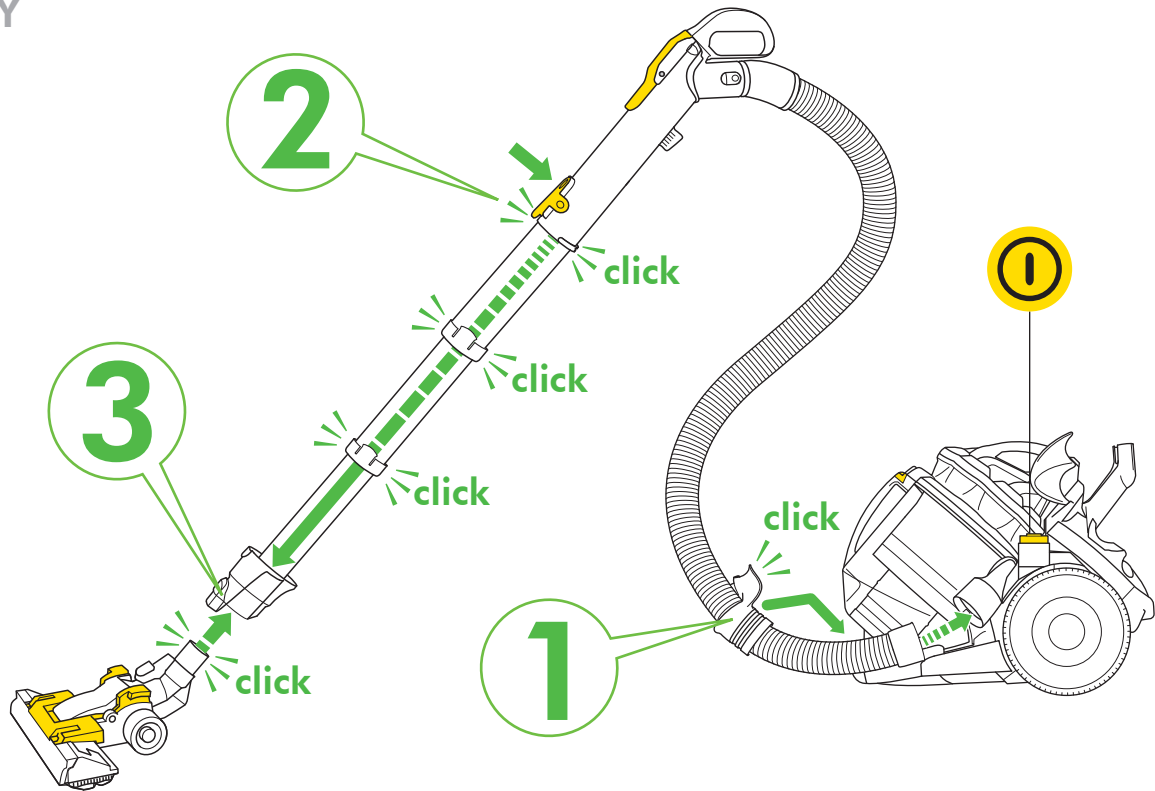

**6** months  
**WASH FILTER**  
Wash filter with cold water at least every 6 months.

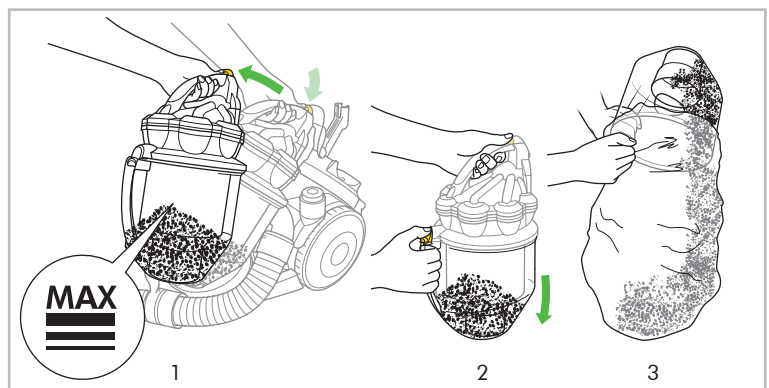
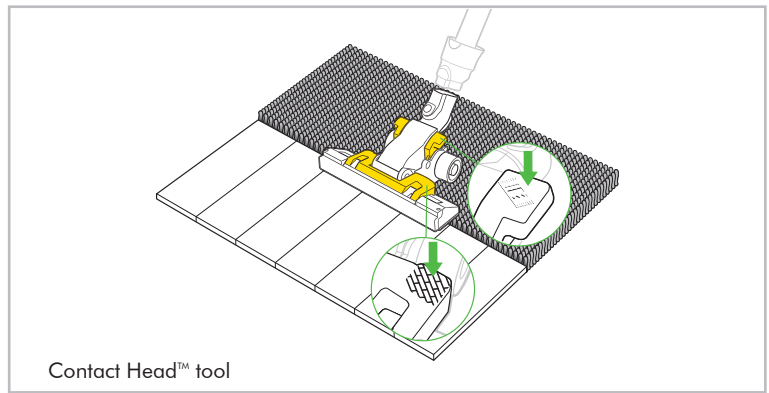

\* Selected models only

**REGISTER FOR YOUR FREE 5 YEAR GUARANTEE TODAY**

After registering for your free 5 year guarantee, your Dyson vacuum cleaner will be covered for parts and labour for 5 years from the date of purchase, subject to the terms of the guarantee.

If you have any query about your Dyson vacuum cleaner, call the Dyson Customer Care Helpline with your serial number and details of where/when you bought the vacuum cleaner. Your serial number can be found on your rating plate which is behind the clear bin™.

Most queries can be solved over the phone by one of our trained Dyson Customer Care Helpline staff.

Note your serial number for future reference



### 3 EASY WAYS TO REGISTER FOR YOUR FREE 5 YEAR GUARANTEE



**REGISTER  
ONLINE**

Visit our website to register your full parts and labour guarantee online.

**[www.dyson.com/register](http://www.dyson.com/register)**



**REGISTER  
BY PHONE**

Call our dedicated Helpline.  
Open 7am–10pm.  
7 days a week.

**UK 0800 298 0298  
IRL 01 475 7109**



**REGISTER  
BY MAIL**

Complete and return the form to Dyson in the envelope supplied.

## GENERAL SAFETY PRECAUTIONS

### ⚠ SAVE THESE INSTRUCTIONS

THIS VACUUM CLEANER IS INTENDED FOR HOUSEHOLD USE ONLY  
READ ALL INSTRUCTIONS BEFORE USING THIS VACUUM CLEANER

When using an electrical appliance, basic precautions should always be followed, including the following:

1. This vacuum cleaner is for domestic use only. Do not use outdoors or on wet surfaces.
2. Do not handle plug or vacuum cleaner with wet hands.
3. Do not allow to be used as a toy. Close attention is necessary when used by or near children.
4. Do not use with damaged cable or plug. If the supply cable is damaged, it must be replaced by Dyson Ltd., our service agents or similarly qualified persons in order to avoid a hazard.
5. If the vacuum cleaner is not functioning properly, has been dropped, damaged, left outdoors, or immersed in liquid, do not use. Contact the Dyson Customer Care Helpline.
6. Do not use the vacuum cleaner if any parts appear to be faulty, missing or damaged.
7. Ensure all parts including clear bin™ are securely attached before using or carrying the vacuum cleaner.
8. This vacuum cleaner is not intended for use by persons (including children) with reduced physical, sensory or mental capabilities, or lack of experience and knowledge, unless they have been given supervision or instruction concerning use of the vacuum cleaner by a person responsible for their safety. Children should be supervised to ensure that they do not play with the vacuum cleaner.
9. Do not leave vacuum cleaner when plugged in. Unplug from outlet when not in use, and before performing user maintenance, connecting or disconnecting the hose or changing accessories.
10. Store the vacuum cleaner indoors. Put the vacuum cleaner away after use with the cable stored safely, to prevent tripping hazards.
11. This vacuum cleaner is fitted with a thermal protection device. If any part of your vacuum cleaner becomes blocked it may cause the device to operate and automatically stop the vacuum cleaner. If this happens, the vacuum cleaner must be switched off, unplugged and allowed to cool down before attempting to check filters or for blockages. Ensure any blockage is cleared before re-starting the vacuum cleaner.
12. Turn off all controls before unplugging.
13. Do not unplug by pulling on cable. To unplug, grasp the plug, not the cable.
14. Do not pull or carry by the cable, use the cable as a handle, close a door on the cable, or pull the cable around sharp edges or corners. Do not run vacuum cleaner over the cable. Keep the cable away from heated surfaces.
15. The use of an extension cable is not recommended.
16. Keep hair, loose clothing, fingers, and all parts of body away from openings and moving parts, such as the brush bar.
17. Do not put any object into openings. Do not use with any opening blocked: keep free of dust, lint, hair, and anything that may reduce air flow.
18. Take extra care when vacuuming on stairs. Always work with the vacuum cleaner at the bottom of the stairs.
19. Keep the vacuum cleaner on the floor. Do not put the vacuum cleaner on chairs, tables etc.
20. Do not shake the vacuum cleaner or press the cyclone release button while carrying the vacuum cleaner, or it could fall and cause injury.
21. Do not use to pick up flammable or combustible liquids, such as petrol, or use in areas where they may be present.
22. Do not pick up anything that is burning or smoking, such as cigarettes, matches, or hot ashes.
23. Check to ensure your electricity supply matches that shown on the rating plate. The vacuum cleaner must only be used as rated.
24. Use only as described in this Dyson Operating Manual. Use only Dyson recommended attachments.
25. Do not use without clear bin™ and filters in place.
26. Do not lubricate any parts, or carry out any maintenance or repair work other than that shown in this Dyson Operating Manual, or as advised by the Dyson Customer Care Helpline.

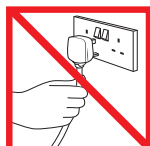

Do not pull on the cable.



Do not store near heat sources.



Do not use near naked flame.



Do not run over the cable.



Do not pick up water or liquids.



Do not pick up burning objects.



Do not use above you on the stairs.



Do not put hands near the brush bar when the vacuum cleaner is in use.

**Tool attachments**

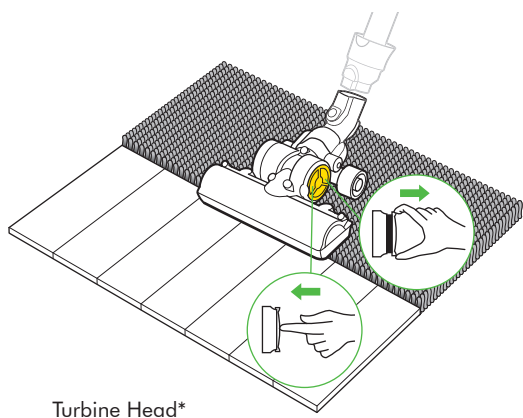

Turbine Head\*

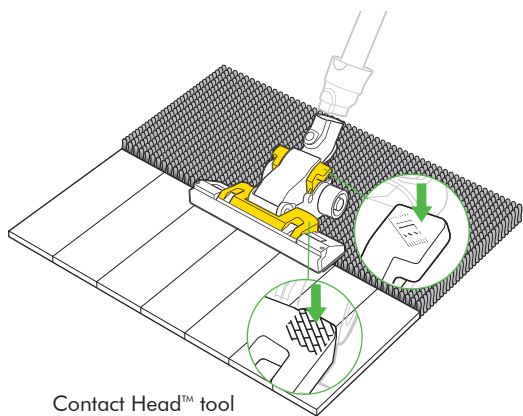

Contact Head™ tool

\* Selected models only

**Brush bar maintenance**

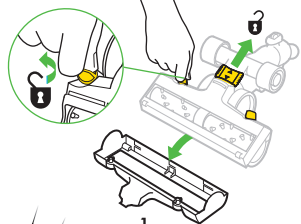
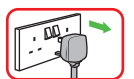

1

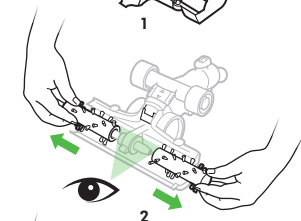

2

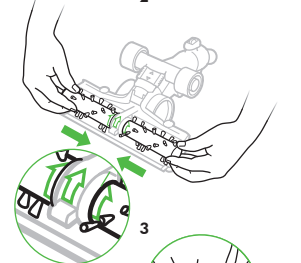

3

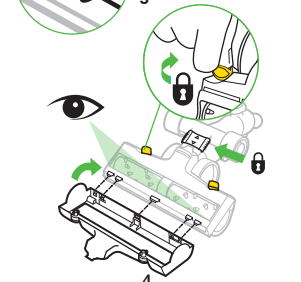

4

**Mini Turbine Head\***

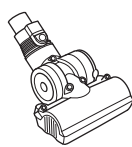

5

**Suction release**

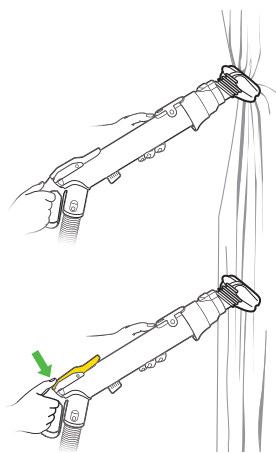

**Tools**

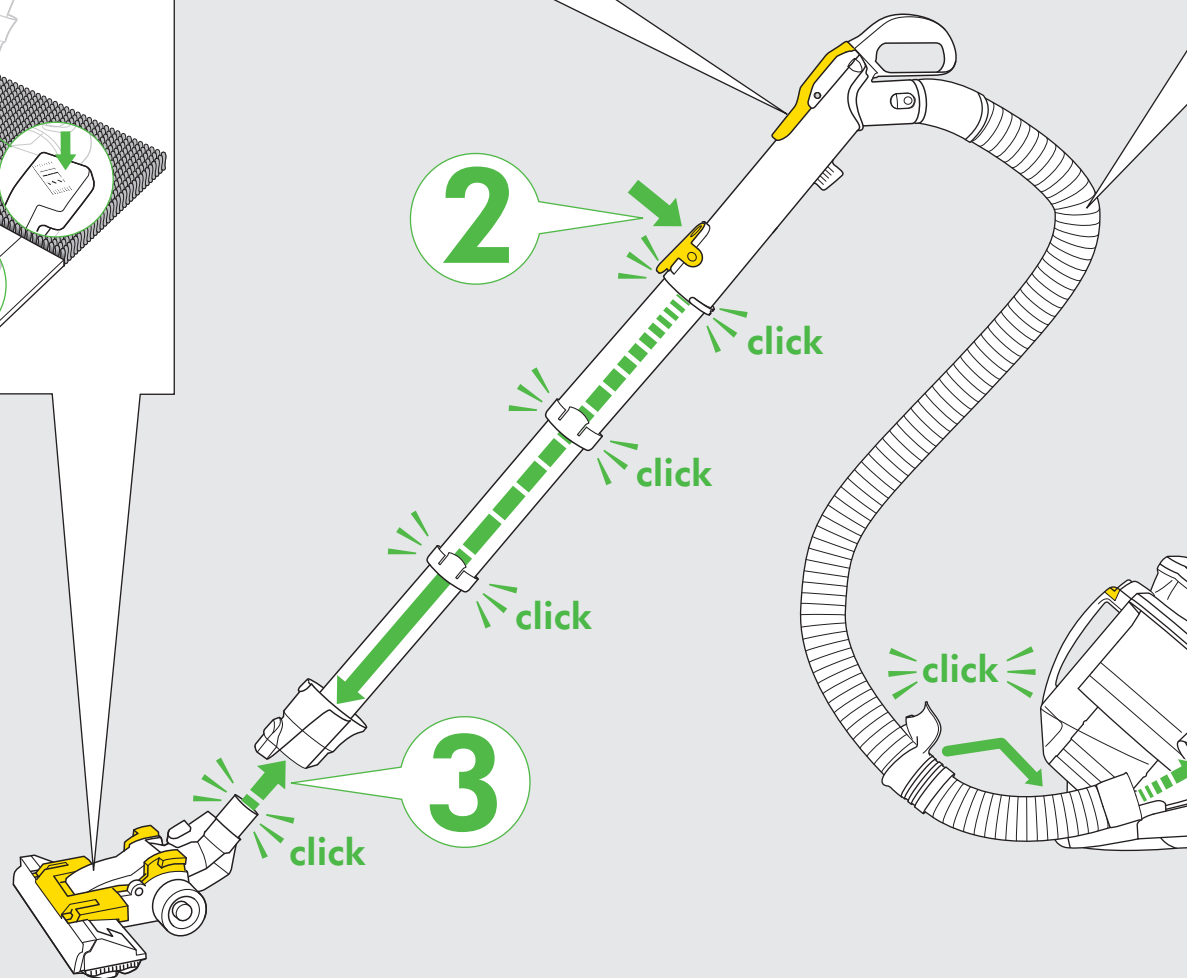
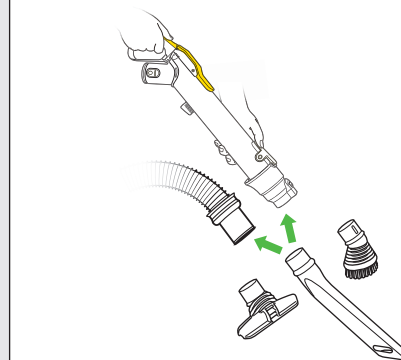

2

click

click

click

3

click

click

**Looking for blockages**

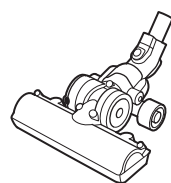
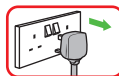

1

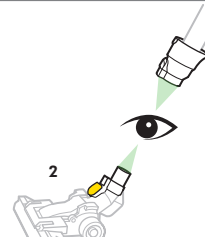

2



3

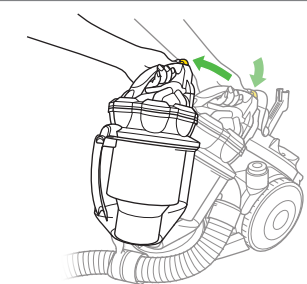

1

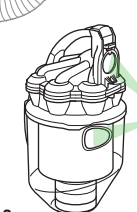

2

## Wrapping and storage

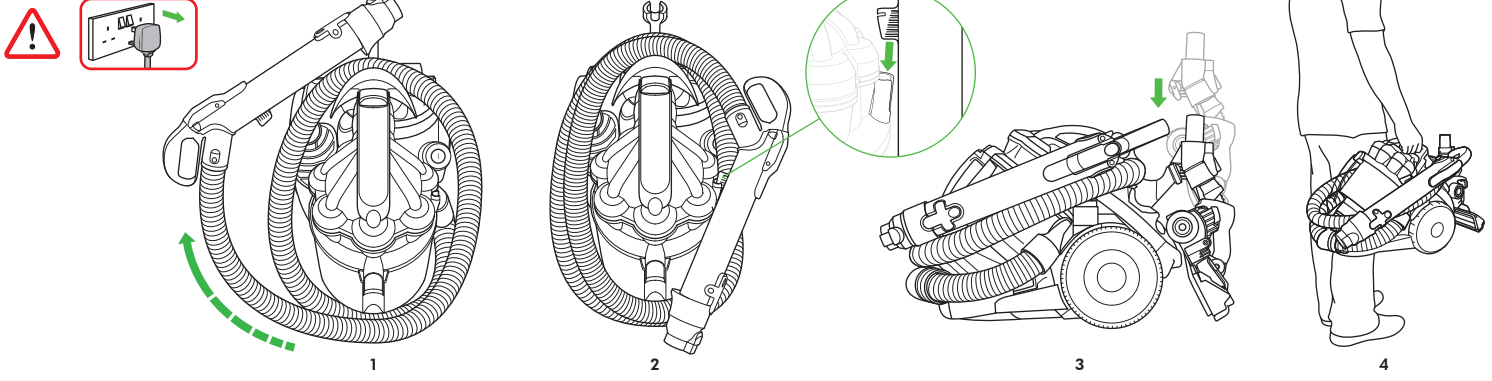

## Emptying the clear bin™

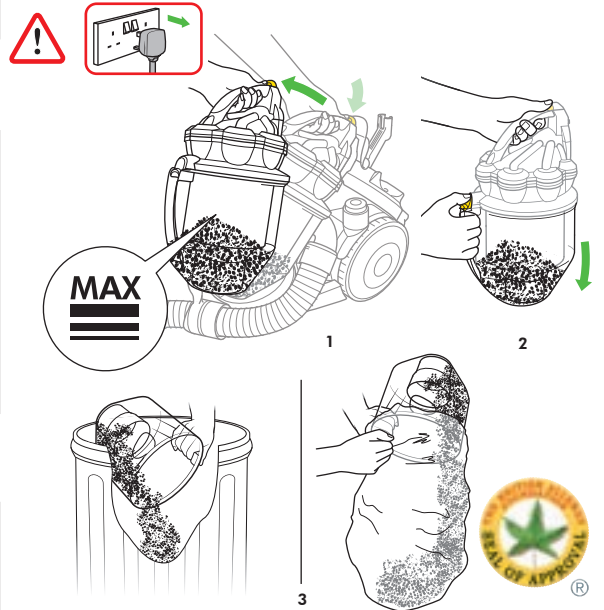

## Power and cable

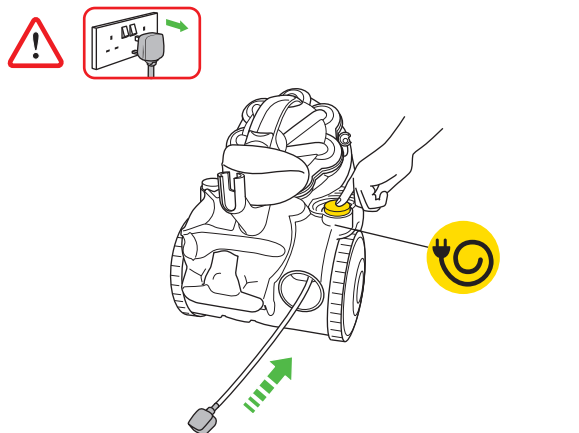
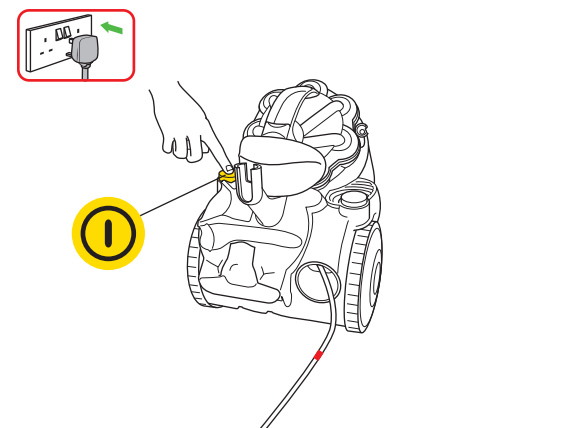

5

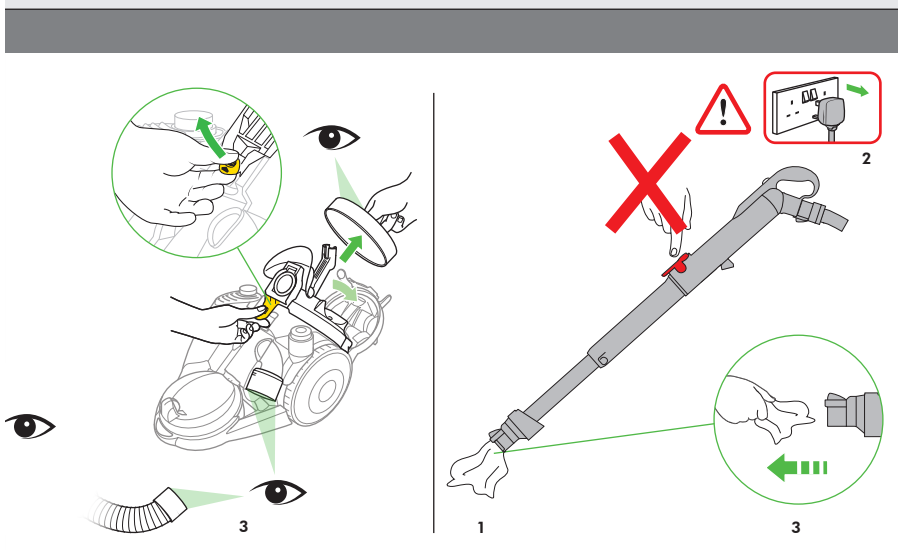
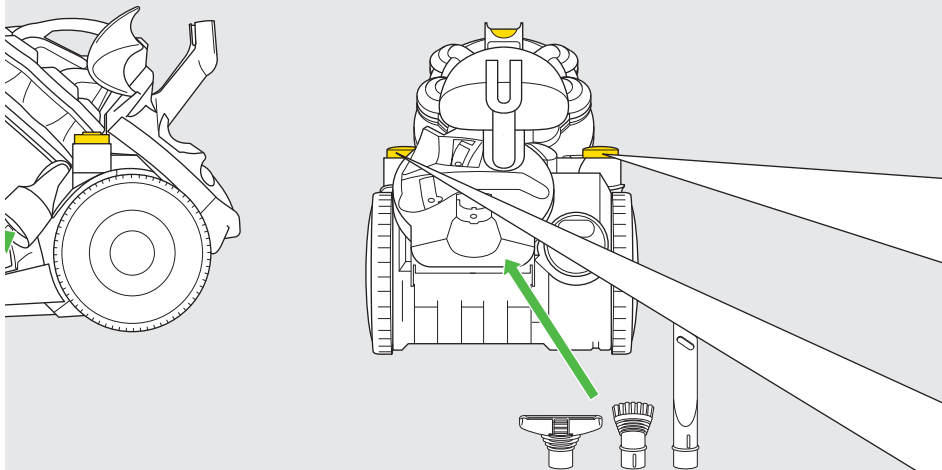
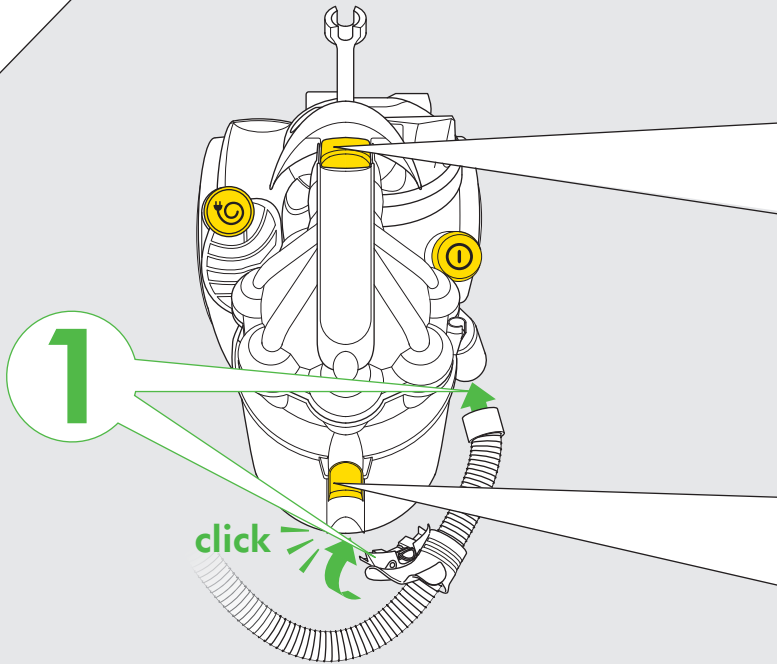

# IMPORTANT!

## WASH FILTER

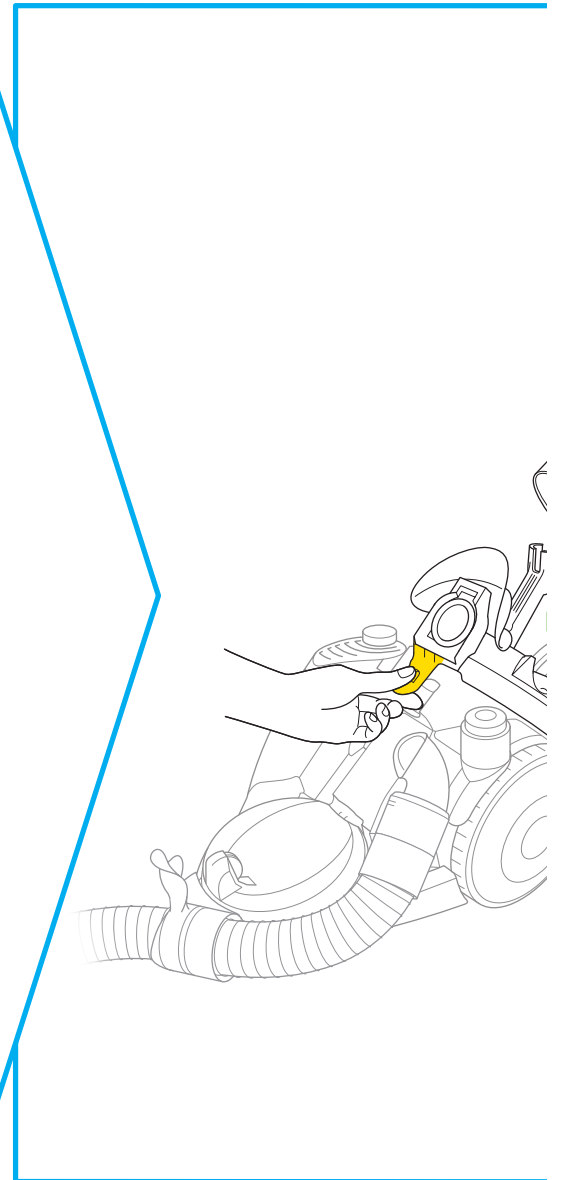
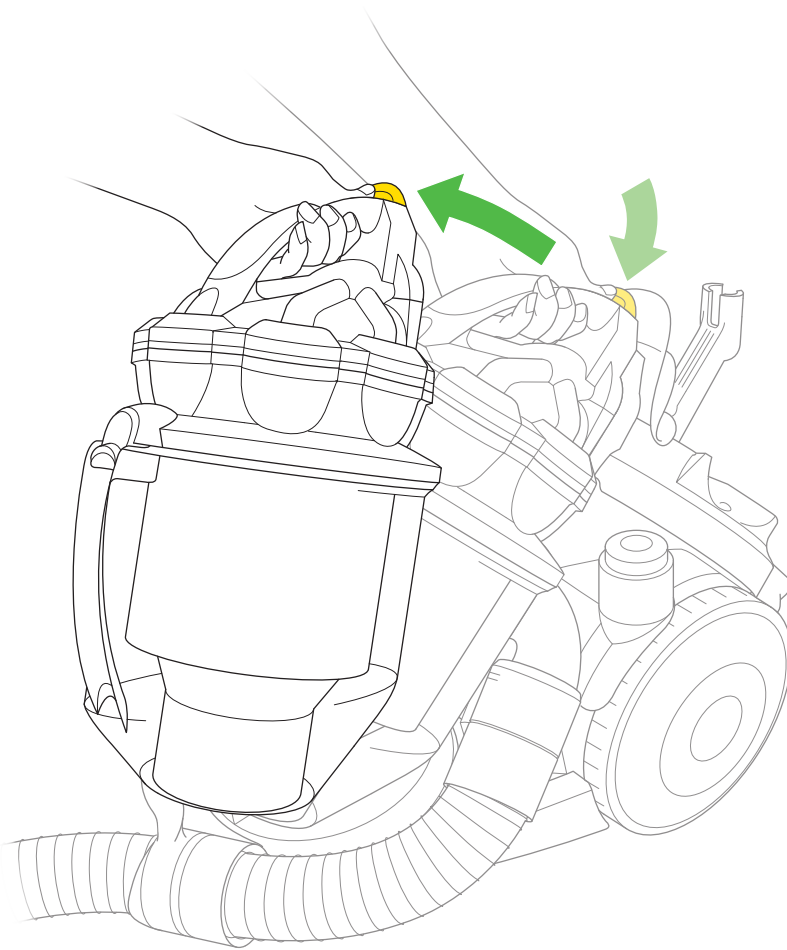
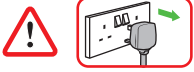

Wash filter with cold water at least every 6 months.

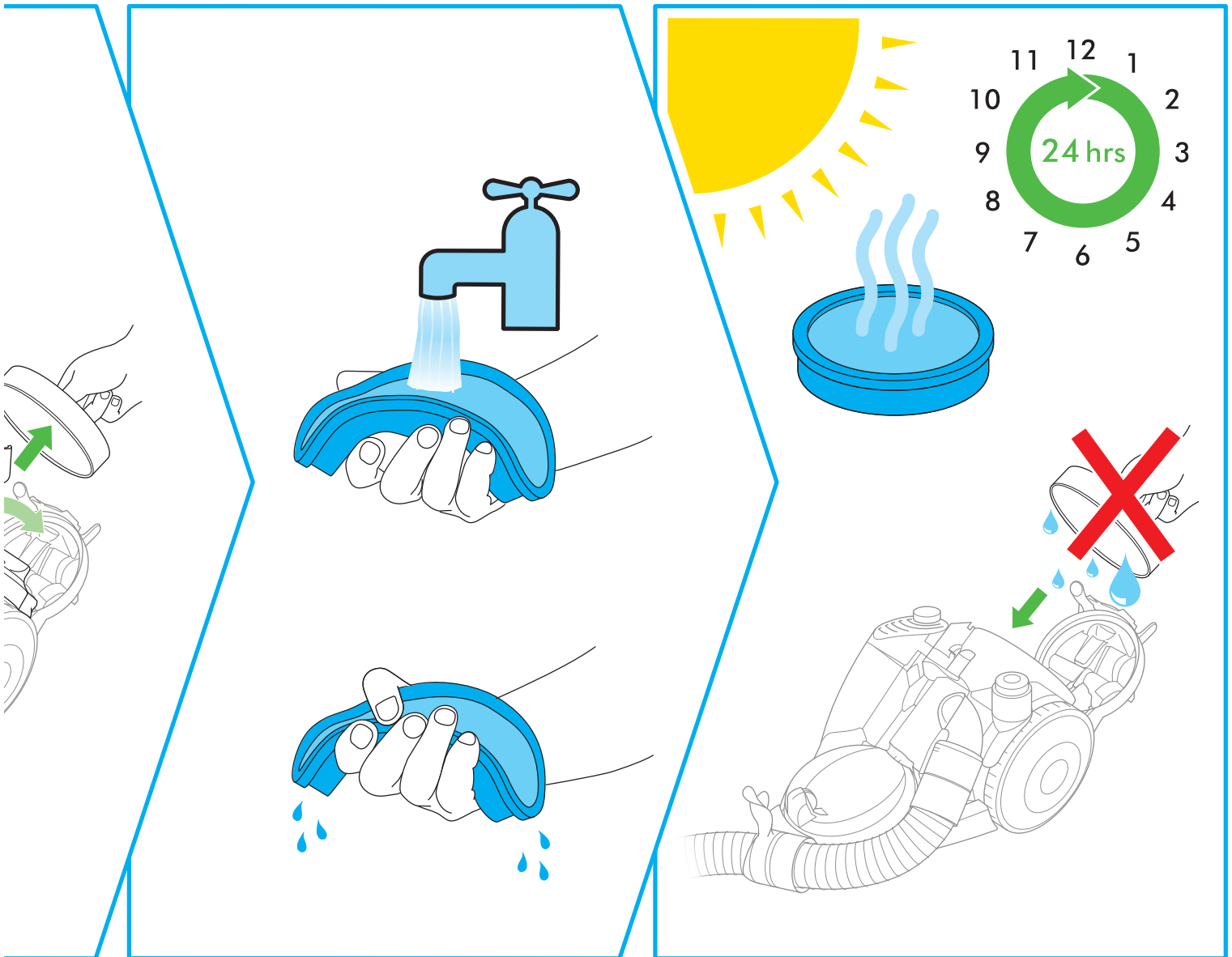

## ASSEMBLY

- Clip hose bracket into front of vacuum cleaner and slide hose end into the inlet.
- Clip the hose into the wand. Insert tools into holster.
- Clip the turbine head into the wand. Press catch to release and adjust the wand length.  
Note: sections 2. and 3. must be fully extended and clicked into position.

## ⚠ USING YOUR DYSON VACUUM CLEANER

### PLEASE NOTE:

- Fine dust such as plaster dust or flour should only be vacuumed in very small amounts.
- Do not use the vacuum cleaner to pick up sharp hard objects, small toys, pins, paper clips etc.
- Consult your flooring manufacturer's recommended instructions before vacuuming and caring for your floorings, rugs and carpets. Some carpets will fuzz if a rotating brush bar is used when vacuuming. If this happens, we recommend vacuuming in hard floors mode and consulting with your flooring manufacturer.
- If used in a garage for car cleaning, care should be taken to wipe the soleplate and wheels with a dry cloth after vacuuming to clean off any sand, dirt or pebbles which could damage delicate floors.
- When vacuuming, certain carpets may generate small static charges in the clear bin™. These are entirely harmless and not associated with the main supply. To minimise any effect from this, do not put your hand or insert any object into the clear bin™ unless you have emptied it and rinsed it out with cold water.
- Only use parts recommended by Dyson; failure to do so could invalidate your guarantee.

## ⚠ EMPTYING THE CLEAR BIN™

### CAUTION:

- Switch OFF and unplug the vacuum cleaner before emptying the clear bin™.
- Empty as soon as the dirt reaches the level of the MAX mark – do not overfill. To remove the clear bin™ from the vacuum cleaner press the button at the rear of the carrying handle. To release the dirt, separate the clear bin™ from the cyclone. The British Allergy Foundation is a UK national charity with the aim of improving awareness, prevention and treatment of allergies. The British Allergy Foundation Seal of Approval is a UK registered trademark.

### PLEASE NOTE:

- Do not use the vacuum cleaner without the clear bin™ in place.
- Emptying into a bag is recommended for allergy sufferers.

## ⚠ CLEANING THE CLEAR BIN™

### CAUTION:

- Do not immerse the whole cyclone in water or pour water into the cyclones.
- Ensure the clear bin™ is completely dry before replacing.

### PLEASE NOTE:

- Do not use detergents, polishes or air fresheners to clean the clear bin™.
- Do not put clear bin™ in a dishwasher.
- Clean the shroud with a cloth or dry brush to remove lint and dust.

## ⚠ WASHING YOUR FILTER

### CAUTION:

- Switch OFF and unplug the vacuum cleaner before removing the filter.
- Ensure filter is completely dry before refitting to the vacuum cleaner.
- It is important to check your filter regularly and wash at least every 6 months according to instructions, to maintain performance.
- Please leave to dry completely for 24 hours.

### PLEASE NOTE:

- The filter may require more frequent washing if vacuuming fine dust.
- Do not use detergents to clean the filter.
- Do not put the filter in a dishwasher, washing machine, tumble dryer, oven, microwave or near a naked flame.

## ⚠ LOOKING FOR BLOCKAGES

### CAUTION:

- Switch OFF and unplug the vacuum cleaner before checking for blockages.
- Beware of sharp objects when clearing blockages.
- Refit all parts of the vacuum cleaner securely before using.

### PLEASE NOTE:

- Clearing blockages is not covered by your vacuum cleaner's limited guarantee. If any part of your vacuum cleaner becomes blocked, it may overheat and then automatically shut off. Unplug the vacuum cleaner and leave to cool down. Clear blockage before restarting.
- Large items may block the tools or wand inlet, if this happens switch the vacuum cleaner off and remove the plug before removing the blockage. Do not operate the wand release catch.

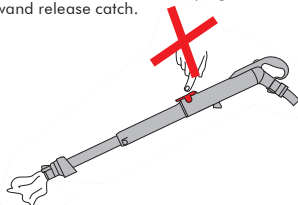

## CONFORMITY INFORMATION

A sample of this product has been tested and found to be in conformity with the following European Directive: 2006/95/EC Low voltage Directive, 93/68/EEC CE Marking Directive, 2004/108/EC EMC Directive.

The symbol  on the product or on its packaging indicates that this product should not be treated as household waste. Instead it should be handed over to the applicable collection point for the recycling of electrical and electronic equipment – this may be your local civic amenity site or a facility provided by the retailer selling the product or a replacement product. By ensuring this product is disposed of correctly, you will help prevent potential negative consequences for the environment and for human health, which could otherwise be caused by inappropriate waste handling of this product. For more detailed information about recycling of this product, please contact the Dyson Customer Care Helpline, your local authority civic amenity site or the retailer selling the product or a replacement product.

## GUARANTEE - TERMS AND CONDITIONS

### DYSON CUSTOMER CARE

If you have a question about your Dyson vacuum cleaner, call the Dyson Customer Care Helpline with your serial number and details of where and when you bought the vacuum cleaner, or contact us via the website. The serial number can be found on the main body of the vacuum cleaner behind the clear bin™. Most questions can be solved over the phone by one of our Dyson Customer Care Helpline staff. If your vacuum cleaner needs service, call the Dyson Customer Care Helpline so we can discuss the available options. If your vacuum cleaner is under guarantee, and the repair is covered, it will be repaired at no cost.

### PLEASE REGISTER AS A DYSON OWNER

THANK YOU FOR CHOOSING TO BUY A DYSON VACUUM CLEANER.

To help us ensure you receive prompt and efficient service, please register as a Dyson owner. There are three ways to do this:

- Online at [www.dyson.com](http://www.dyson.com)
- By calling the Dyson Customer Care Helpline: UK: 0800 298 0298 or IRL: 01 475 7109.
- By completing and returning the enclosed form to us by mail. This will confirm ownership of your Dyson vacuum cleaner in the event of an insurance loss, and enable us to contact you if necessary.

### LIMITED 5 YEAR GUARANTEE

Terms and conditions of the Dyson 5 year limited guarantee.

### WHAT IS COVERED

- The repair or replacement of your vacuum cleaner (at Dyson's discretion) if your vacuum cleaner is found to be defective due to faulty materials, workmanship or function within 5 years of purchase or delivery (if any part is no longer available or out of manufacture Dyson will replace it with a functional replacement part).
- Use of the vacuum cleaner in the UK and Republic of Ireland.

### WHAT IS NOT COVERED

Dyson does not guarantee the repair or replacement of a product as a result of:

- Normal wear and tear (e.g. fuse, belt, brush bar, batteries etc).
- Accidental damage, faults caused by negligent use or care, misuse, neglect, careless operation or handling of the vacuum cleaner which is not in accordance with the Dyson Operating Manual.
- Blockages – please refer to the Dyson Operating Manual for details of how to unblock your vacuum cleaner.
- Use of the vacuum cleaner for anything other than normal domestic household purposes.
- Use of parts not assembled or installed in accordance with the instructions of Dyson.
- Use of parts and accessories which are not Dyson Genuine Components.
- Faulty installation (except where installed by Dyson).
- Repairs or alterations carried out by parties other than Dyson or its authorised agents.
- If you are in any doubt as to what is covered by your guarantee, please call the Dyson Customer Care Helpline on UK: 0800 298 0298 or IRL: 01 475 7109.

### SUMMARY OF COVER

- The guarantee becomes effective at the date of purchase (or the date of delivery if this is later).
- You must provide proof of delivery/purchase before any work can be carried out on your vacuum cleaner. Without this proof, any work carried out will be chargeable. Please keep your receipt or delivery note.
- All work will be carried out by Dyson or its authorised agents.
- Any parts which are replaced will become the property of Dyson.
- The repair or replacement of your vacuum cleaner under guarantee will not extend the period of guarantee.
- The guarantee provides benefits which are additional to and do not affect your statutory rights as a consumer.

### ABOUT YOUR PRIVACY

Your information will be held by Dyson Limited and its agents for promotional, marketing and servicing purposes.

If your personal details change, if you change your mind about any of your marketing preferences or if you have any queries about how we use your information, please let us know by contacting Dyson Limited, Tetbury Hill, Malmesbury, Wiltshire, SN16 0RP England, or by calling the Dyson Customer Care Helpline on UK 0800 298 0298 or IRL 01 475 7109. Or you can email us at [askdyson@dyson.co.uk](mailto:askdyson@dyson.co.uk).

For more information on how we protect your privacy, please see our privacy policy on [www.dyson.co.uk](http://www.dyson.co.uk).



## PRODUCT INFORMATION

Maximum product weight 8.05kg, Voltage 230 – 240V, Maximum Power 1400W.  
Please note small details may vary from those shown.  
This product is protected by the following intellectual property rights:

### PATENT/PATENT APPLICATION NUMBERS:

US 2004/0128789; JP 2004-537336; EP 1361812; AU 2002225207; EP 1361814;  
JP 2004-520137; US 7,018,439; AU 2001240894; EP 1268076; JP 2003-528704;  
US 6,835,222; AU 2002-225232; EP 1361815; JP 2004-520139; US 6,974,488; AU 637 272;  
EP 0636338; JP 1948 863; US 5,078,761; AU 697029; EP 0800360; JP 3449723;  
US 5,893,936; AU 2002241151; EP 1377196; JP 2004-528087; US 6,989,039; GB 2416483;  
WO 2006/008451; AU 2003269161; EP 1542574; JP 2006-500138; US 2006-0162119;  
AU 2003269349; EP 1542576; JP 2006-500137; US 2006-162119; GB 2407022;  
JP 2005-537879; AU 1365676; EP 1365676; JP 2002-570878; US 2004-0078925;  
AU 2003252873; EP 1380247; JP 2004-100960; US 2004-0111828; AU 2002341143;  
EP 1443842; JP 2003-541416; US 10/494,294; AU 2002337322; EP 1443841;  
JP 2003-541417; US 10/494,297.

Equivalent patents, registered designs and applications exist in other countries.

# IMPORTANT!

## WASH FILTER



Wash filter with cold water at least every 6 months.



### Dyson Customer Care

If you have a question about your Dyson vacuum cleaner, call the Dyson Customer Care Helpline with your serial number and details of where and when you bought the vacuum cleaner, or contact us via the Dyson website. The serial number can be found on the main body of the vacuum cleaner behind the clear bin™.

**UK Dyson Customer Care**  
[askdyson@dyson.co.uk](mailto:askdyson@dyson.co.uk)  
0800 298 0298

Dyson Ltd, Tetbury Hill, Malmesbury, Wiltshire SN16 0RP

**IRL Dyson Customer Care**  
[askdyson@dyson.co.uk](mailto:askdyson@dyson.co.uk)  
01 475 7109

Dyson Ireland Ltd, Unit 10, Greenogue Business Park,  
Rothcoole, Dublin 24

[www.dyson.com](http://www.dyson.com)





# GUARANTEE FORM

Date of purchase  /  /

Country of purchase  UK  Ireland

Serial number

Title  Surname

First name

Address

Postcode

e-mail

Telephone

From time to time, we'd like to tell you about new Dyson technology and services. If you'd prefer us NOT to keep in touch, please tick this box.

## 3 EASY WAYS TO REGISTER FOR YOUR FREE 5 YEAR GUARANTEE

### REGISTER ONLINE



Visit our website to register your full parts and labour guarantee online.

[www.dyson.com/register](http://www.dyson.com/register)

### REGISTER BY PHONE



Call our dedicated Helpline. Open 7am – 10pm, 7 days a week.

UK 0800 298 0298  
IRL 01 475 7109

### REGISTER BY MAIL



Complete and return the form to Dyson in the envelope supplied.